



United Nations Human Settlements Programme

CONSTRUCTED WETLANDS MANUAL

CONSTRUCTED WETLANDS MANUAL



CONSTRUCTED WETLANDS MANUAL

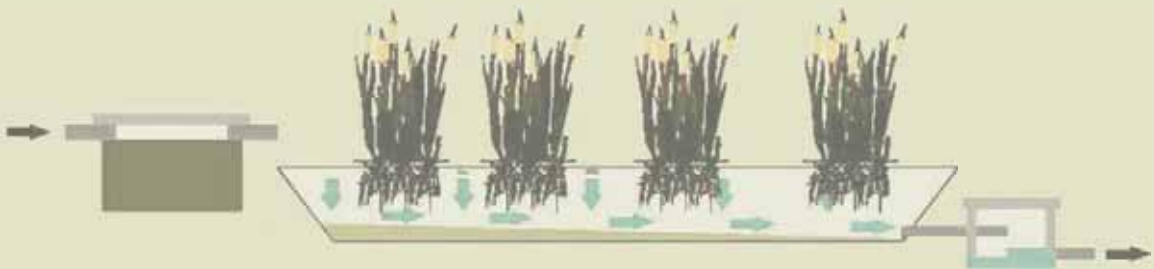

Copyright © United Nations Human Settlements Programme (UN-HABITAT), 2008

All rights reserved. The material in this publication may be reproduced in whole or in part or in any form for education or non-profit uses without special permission from the copyright holder, provided acknowledgment of the source is made. UN-HABITAT would appreciate receiving a copy of any publication which uses this publication as a source.

Citation

UN-HABITAT, 2008. *Constructed Wetlands Manual*. UN-HABITAT Water for Asian Cities Programme Nepal, Kathmandu.

United Nations Human Settlements Programme (UN-HABITAT)

P.O. Box 30030, Nairobi 00100, Kenya
Tel (254-20) 7621234
Fax (254-20) 7624266
E-mail infohabitat@unhabitat.org
Web www.unhabitat.org

HS Number: HS/980/08E

ISBN Number: (Volume) 978-92-1-131963-7

Disclaimer: *The designations employed and the presentation of the material in this publication do not imply the expression of any opinion whatsoever on the part of the Secretariat of the United Nations concerning the legal status of any country, territory, city or area, or of its authorities or concerning delimitation of its frontiers or boundaries or regarding its economic system or degree of development. The analysis, conclusions and recommendations of the report do not necessarily reflect the views of the United Nations Human Settlements Programme (UN-HABITAT), the Governing Council of UNHABITAT or its Member States.*

April, 2008



foreword

In a rapidly urbanizing world, poor environmental sanitation has emerged as a major challenge, threatening the health and livelihoods particularly of the poor. It is also now clear, that if business continues as usual, the sanitation related MDG to halve by 2015, the proportion of people without sustainable access to basic sanitation will not be met.

Mere provision of toilets is not enough to ensure good environmental sanitation. Excreta from toilets needs to be transported and disposed of safely without creating an environmental health hazard. While in the large cities of industrialized countries this is usually achieved through centralized wastewater management systems with advanced treatment technologies, such systems tend to be expensive and difficult to operate.

Smaller, decentralized, wastewater management and treatment systems such as constructed wetlands can be a viable alternative for many urban areas in developing countries. Constructed wetlands are relatively inexpensive to build where land is affordable and can be easily operated and maintained even by the community.

This manual, drawing upon a number of examples in Nepal, provides basic guidance on the design, construction and operation and maintenance of constructed wetlands and also indicates situations where this may not be a feasible alternative.

I believe that the experiences and the case studies described in this manual can serve as useful reference material for municipal officials and water and sanitation professionals and hope that it will stimulate local action for affordable and simple wastewater management systems and technologies.

Anna Kajumulo Tibaijuka
Executive Director, UN-HABITAT



Preface

With support from the Water and Sanitation Trust fund, UN-HABITAT is implementing the Water For Asian Cities Programme (WAC) which is currently operational in India, People's Republic of China, Nepal, Lao PDR and Vietnam and is being extended to Cambodia, Indonesia and Pakistan.

With the overarching goal of creating an enabling environment for pro-poor investments in cities, the WAC programme is demonstrating innovative approaches for improving access to water and sanitation for the poor. These pilot and demonstration projects usually aim to tackle difficult water and environmental sanitation problems through practical community based approaches. One such problem confronting the rapidly urbanizing cities in Asia is the safe treatment and disposal of wastewater. Conventional solutions using advanced technologies are simply not affordable or are too complex to maintain in most small and medium sized towns.

Under the WAC's "normative" work programme, lessons learnt through pilot projects are documented for wider dissemination. This publication on the design, construction, operation and maintenance of constructed wetlands was prepared under the WAC programme on the basis of experiences in Nepal and in recognition of the need for a viable alternative to conventional wastewater treatment and disposal technologies. It should however be noted that constructed wetlands have their limitations—the unavailability or the cost of land can make them unviable; and climatological aspects and wastewater parameters can affect their proper functioning.

The preparation of the manual was coordinated by Dr. Roshan Shrestha, Chief Technical Adviser, WAC, Nepal. The WAC programme also appreciates the contribution of Mr. Shirish Singh, Dr. Guenter Langergraber and Dr. Elif Asuman Korkusuz of the University of Natural Resources and Applied Sciences Vienna in the development of this manual.

Andre Dzikus

Chief

Water and Sanitation Section II

Water, Sanitation and Infrastructure Branch

United Nations Human Settlements Programme (UN-HABITAT)



Contents

iii	foreword	
v	preface	
1	chapter ONE introduction	
3	chapter TWO what is a constructed wetland?	
	2.1 Advantages of constructed wetlands	5
	2.2 Limitations of constructed wetlands	5
7	chapter THREE configurations of constructed wetland	
	3.1 Horizontal Flow (HF)	7
	3.2 Vertical Flow (VF)	8
	3.3 Hybrid	9
11	chapter FOUR how does a constructed wetland function	
15	chapter FIVE design of constructed wetland	
	5.1 Preliminary treatment	15
	5.2 Primary treatment	16
	5.2.1 <i>Septic Tank</i>	16
	5.2.2 <i>Anaerobic Baffle Reactor (Improved septic tank)</i>	17
	5.3 Sizing of the wetland	18
	5.3.1 <i>Sizing based on equation</i>	18
	5.3.2 <i>Sizing based on specific area requirement per Population Equivalent</i>	20

5.4	Depth	21
5.4.1	<i>HF wetland</i>	21
5.4.2	<i>VF wetland</i>	22
5.5	Bed cross section area (only for HF wetland)	22
5.6	Media selection	23
5.6.1	<i>HF wetland</i>	23
5.6.2	<i>VF wetland</i>	24
5.7	<i>Bed Slope</i>	24
5.8	Sealing of the bed	25
5.9	Inlet and outlet structures	26
5.9.1	<i>Inlets</i>	26
5.9.2	<i>Outlet</i>	32
5.10	Vegetation	33

35 chapter SIX construction of constructed wetland

6.1	Basin Construction	35
6.2	Lining of the basin	35
	<i>Permeability test</i>	36
6.3	Substrate filling	37
6.3.1	<i>HF wetland</i>	37
6.3.2	<i>VF wetland</i>	37
	<i>Sand suitability test</i>	38
6.4	Inlet and Outlet Structures	39
6.5	Planting vegetation	40
6.6	Water level management for the growth of vegetation	41

47 chapter SEVEN operation and maintenance

7.1	Start-up	47
7.2	Routine operation	47
7.2.1	<i>Adjustment of water levels</i>	48
7.2.2	<i>Maintenance of flow uniformity</i>	48
7.2.3	<i>Vegetation management</i>	48
7.2.4	<i>Odor Control</i>	50
7.2.5	<i>Maintenance of berms (Walls)</i>	51
7.3	Long-term operations	51

53 chapter EIGHT constructed wetland for sludge drying

55 chapter NINE case studies

9.1 Hospital wastewater treatment (Dhulikhel Hospital)	55
9.1.1 <i>Technical description</i>	55
9.1.2 <i>Performance</i>	57
9.1.3 <i>Operation and maintenance</i>	58
9.1.4 <i>Costs</i>	58
9.2 Combined laboratory and domestic wastewater treatment and reuse (ENPHO)	58
9.2.1 <i>Technical description</i>	58
9.2.2 <i>Performance</i>	59
9.2.3 <i>Operation and maintenance</i>	59
9.2.4 <i>Costs</i>	61
9.3 Institutional wastewater treatment (Kathmandu University)	61
9.3.1 <i>Technical description</i>	61
9.3.2 <i>Performance</i>	62
9.3.3 <i>Operation and maintenance</i>	64
9.3.4 <i>Costs</i>	64
9.4 Municipal wastewater treatment (Sunga)	64
9.4.1 <i>Technical description</i>	64
9.4.2 <i>Performance</i>	66
9.4.3 <i>Operation and maintenance</i>	67
9.4.4 <i>Costs</i>	67
9.5 Grey water treatment (Private residence)	67
9.5.1 <i>Technical description</i>	67
9.5.2 <i>Performance</i>	69
9.5.3 <i>Operation and maintenance</i>	69
9.5.4 <i>Costs</i>	69
9.6 Septage and landfill leachate treatment (Pokhara)	70
9.6.1 <i>Technical description</i>	70
9.6.2 <i>Costs</i>	71

73 references

77 Annex - A: How to treat raw sewage with constructed wetlands: An overview of the French systems

Tables

Table 1	Major International Conferences	5
Table 2	Pollutant Removal Mechanisms in Constructed Wetlands	12
Table 3	Basic design criteria for two-compartment septic tank	16
Table 4	Basic design criteria for an anaerobic baffle reactor	18
Table 5	Fortnightly O & M action list	51
Table 6	Two-monthly O & M action list	52
Table 7	Yearly O & M action list	52
Table 8	Technical description of Dhulikhel Hospital Constructed Wetland	56
Table 9	Technical description of ENPHO Constructed Wetland	59
Table 10	Technical description of Kathmandu University Constructed Wetland	62
Table 11	Technical description of Sunga Constructed Wetland	65
Table 12	Average concentrations of pollutants at Sunga	67
Table 13	Technical description of Constructed Wetland at Private Residence	68

Figures

Figure 1	Improved sanitation coverage in 2002	1
Figure 2	Components of a constructed wetland	3
Figure 3	Schematic cross- section of a horizontal flow constructed wetland	8
Figure 4	Schematic cross- section of a vertical flow constructed wetland	9
Figure 5	Pollutant removal mechanism	11
Figure 6	Oxygen transfer from roots	12
Figure 7	Nitrogen transformations in a constructed wetland	13
Figure 8	Schematic cross- section of a two-compartment septic tank	16
Figure 9	Schematic cross- section of an up flow anaerobic baffle reactor	17
Figure 10	K_{BOD} for HF plotted against Temperature for substrate depth 40 cm and porosity 40%	19
Figure 11	K_{BOD} for VF plotted against Temperature for substrate depth 70 cm and porosity 30%	19
Figure 12	Specific area requirement per PE for HF and VF wetland for different specific wastewater discharges	20
Figure 13	Substrate arrangement in a HF wetland	24
Figure 14	Substrate arrangement in a VF wetland	25
Figure 15	Substrate arrangement in a VF wetland	27
Figure 16	Outlet devices	32
Figure 17	Typical grain size distribution	38
Figure 18	Sand suitability test	38
Figure 19	The effect of wetland layout configuration on effective flow distribution	39
Figure 20	Results of sand suitability test	39
Figure 21	Technique for planting rhizome cuttings	40
Figure 22	Substrate profile for sludge drying bed	54
Figure 23	Schematic representation of constructed wetland at Dhulikhel Hospital	55
Figure 24	Performance of constructed wetland at Dhulikhel Hospital from 1997 to 2006	57
Figure 25	Schematic representation of constructed wetland at ENPHO	59
Figure 26	Performance of constructed wetland at ENPHO from 2002 to 2006	60
Figure 27	Schematic representation of constructed wetland at Sunga	61
Figure 28	Performance of constructed wetland at Kathmandu University from 2001 to 2006	63
Figure 29	Schematic representation of constructed wetland at Kathmandu University	64
Figure 30	Performance of constructed wetland at Sunga from August 2006 to August 2007	66
Figure 31	Schematic representation of constructed wetland at private residence	67
Figure 32	Performance of constructed wetland at private residence from May 1998 to May 2000	69
Figure 33	Schematic representation of septage and landfill leachate treatment plant	70

introduction

ALMOST all of the world's major cities have gone in to the 21st Century facing an environmental crisis. The world's cities not only face the challenge of supplying adequate sanitation facilities to its residents (Figure 1), but must also ensure that the available water resources are not contaminated. The discharge of untreated wastewater is a major contributor to deteriorating health conditions and pollution of nearby water bodies. The problem is expected to increase due to rapid pace of urban growth, unless measures are taken to control and treat effluents.

The approach of centralized, water-based sewer systems was applied to attain considerable public health improvement in urban areas of industrialized countries. However, the cost of such a sewer-based system is enormous and is unaffordable to many of the developing countries. Centralized systems require conventional (intensive) treatment systems, which are technologically complex and financially expensive, so many communities of the developing countries cannot afford the construction and operation of conventional treatment systems. For these communities, alternative natural treatment systems, which are simple

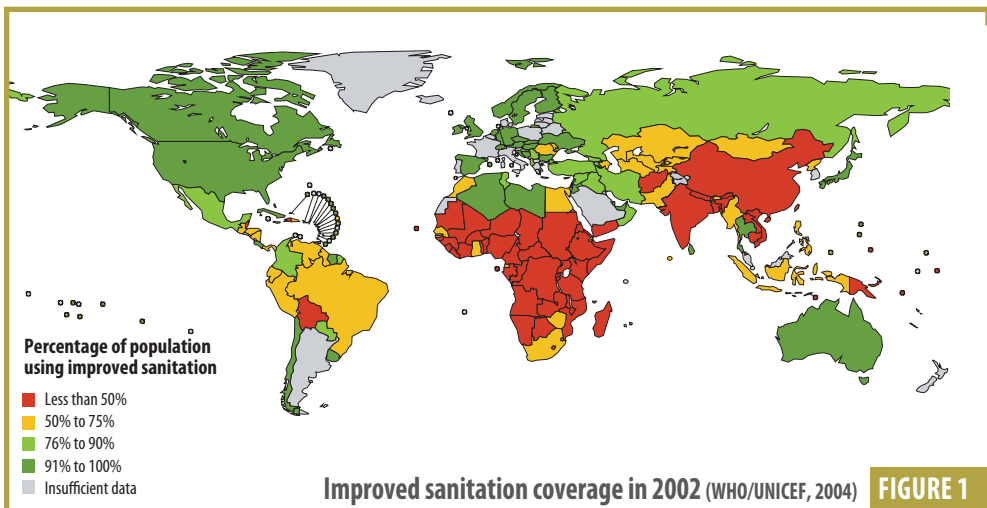

in the construction and operation, yet inexpensive and environmentally friendly, seem to be appropriate.

Constructed Wetlands (CWs) are a natural, low-cost, eco-technological biological wastewater treatment technology designed to mimic processes found in natural wetland ecosystems, which is now standing as the potential alternative or supplementary systems for the treatment of wastewater.

This manual is not a plea to implement constructed wetlands for wastewater treatment but aims at providing a comprehensive description of the issues related to wastewater treatment through constructed wetlands. This manual has been prepared as a general guide to the design, construction, operation and maintenance of constructed wetlands for the treatment of domestic wastewater as well as introduction to the design of constructed wetland for sludge drying.

Chapter 2 presents an introduction of the constructed wetlands and its development. Chapter 3 describes the configurations of constructed wetlands and gives insight of the horizontal and vertical flow constructed wetlands. Chapter 4 aims at providing an overview of working principle of constructed wetlands and describes the removal mechanisms of specific pollutants. Chapter 5 illustrates the various aspects to be considered during the design of a subsurface flow constructed wetland. The constructional aspects of the wetland are illustrated with pictures in Chapter 6. Chapter 7 states the operation and maintenance of wetlands for smooth functioning and Chapter 8 gives an introduction on the design of constructed wetlands for sludge drying. Six case studies of constructed wetlands in Nepal for the treatment of different types of wastewater are described in Chapter 9. The case study describes the technical details, performance of the wetland, its operation and maintenance as well as associated costs.

what is a constructed wetland?

A **CONSTRUCTED** wetland is a shallow basin filled with some sort of filter material (substrate), usually sand or gravel, and planted with vegetation tolerant of saturated conditions. Wastewater is introduced into the basin and flows over the surface or through the substrate, and is discharged out of the basin through a structure which controls the depth of the wastewater in the wetland.

A constructed wetland comprises of the following five major components:

- Basin
- Substrate
- Vegetation
- Liner
- Inlet/Outlet arrangement system.

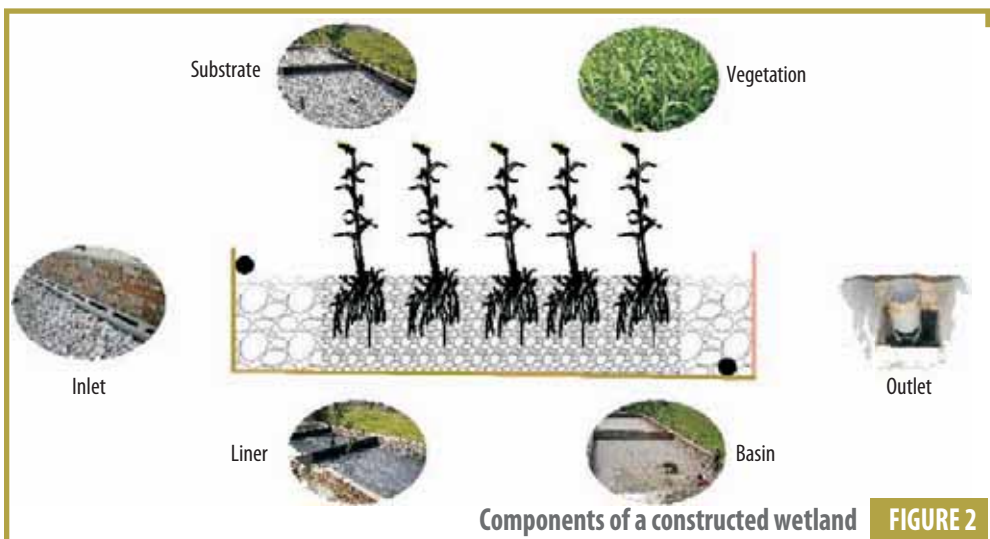

The excavated basin is filled with a permeable substrate (rock, gravel, sand and soil have all been used), and the water level is maintained below the top of the substrate so that all flow is supposed to be subsurface. This substrate supports the roots system of the same types of emergent vegetation, which are planted in the top surface of the substrate. The equal distribution and collection of wastewater is achieved by inlet and outlet arrangement systems. A liner is used, if the protection of the groundwater is important.

Since the 1950s, CWs have been used effectively to treat different wastewaters with different configurations, scales and designs throughout the world. Existing systems of this type range from those serving single-family dwellings to large-scale municipal systems. Nowadays, constructed wetlands are common alternative treatment systems in Europe in rural areas and over 95% of these wetlands are subsurface flow wetlands. In the following years, the number of these systems is expected to be over 10,000 only in Europe (Platzer, 2000).

Even though the potential for application of wetland technology in the developing world is enormous, the rate of adoption of wetlands technology for wastewater treatment in those countries has been slow. It has been identified that the current limitations to widespread adoption of CW technology for wastewater treatment in developing countries is due to the fact that they have limited knowledge and experience with CW design and management.

Due to the enormous potential of constructed wetlands for wastewater treatment, a number of international conferences are organized for the dissemination of the new developments in this field. Apart from other international conferences, the International Water Association (IWA) organizes the International Conference on Wetland Systems for Water Pollution Control every two year. The list of the IWA international conferences are shown in Table 1.

TABLE 1 Major international conferences

CONFERENCE	DATE	VENUE
1 st International Conference on Wetland Systems for Water Pollution Control	1988	Chattanooga, USA
2 nd International Conference on Wetland Systems for Water Pollution Control	24 to 28 Sept 1990	Cambridge, U.K.
3 rd International Conference on Wetland Systems for Water Pollution Control	30 Nov to 03 Dec 1992	Sydney, Australia
4 th International Conference on Wetland Systems for Water Pollution Control	6 to 10 Nov 1994	Guangzhou, P.R. China
5 th International Conference on Wetland Systems for Water Pollution Control	15 to 19 Sept 1996	Vienna, Austria
6 th International Conference on Wetland Systems for Water Pollution Control	27 Sept to 02 Oct 1998	Sao Pedro, Brazil
7 th International Conference on Wetland Systems for Water Pollution Control	11 to 16 Nov 2000	Florida, USA
8 th International Conference on Wetland Systems for Water Pollution Control	16 to 19 Sept 2002	Arusha, Tanzania
9 th International Conference on Wetland Systems for Water Pollution Control	26 to 30 Sept 2004	Avignon, France
10 th International Conference on Wetland Systems for Water Pollution Control	25 to 29 Sept 2006	Lisbon, Portugal
11 th International Conference on Wetland Systems for Water Pollution Control	01 to 07 Nov 2008	Indore, India

2.1 Advantages of constructed wetlands

- wetlands can be less expensive to build than other treatment options
- utilization of natural processes,
- simple construction (can be constructed with local materials),
- simple operation and maintenance,
- cost effectiveness (low construction and operation costs),
- process stability.

2.2 Limitations of constructed wetlands

- large area requirement
- wetland treatment may be economical relative to other options only where land is available and affordable.
- design criteria have yet to be developed for different types of wastewater and climates.

configurations of constructed wetland

THERE are various design configurations of constructed wetlands (Haberl, 1999) and they can be classified according to the following items:

- Life form of the dominating macrophytes (free-floating, emergent, submerged),
- Flow pattern in the wetland systems (free water surface flow; subsurface flow: horizontal and vertical),
- Type of configurations of the wetland cells (hybrid systems, one-stage, multi-stage systems),
- Type of wastewater to be treated,
- Treatment level of wastewater (primary, secondary or tertiary),
- Type of pretreatment,
- Influent and effluent structures,
- Type of substrate (gravel, soil, sand, etc.), and
- Type of loading (continuous or intermittent loading).

Among the various classifications listed above, only subsurface flow constructed wetlands have been considered in this manual. There are mainly two types of flow directions used in these wetlands. These are horizontal flow (HF) and vertical flow (VF).

3.1 Horizontal flow (HF)

Figure 3 shows schematic cross section of a horizontal flow constructed wetland. It is called HF wetland because the wastewater is fed in at the inlet and flow slowly through the porous substrate under the surface of the bed in a more or less horizontal path until it reaches the outlet zone. During this passage the wastewater will come into contact with a network of aerobic, anoxic and anaerobic zones. The aerobic zones will be around the roots and rhizomes of the wetland vegetation that leak oxygen into the substrate. During the passage of wastewater through the rhizosphere, the wastewater is cleaned by microbiological

degradation and by physical and chemical processes (Cooper *et al.* 1996). HF wetland can effectively remove the organic pollutants (TSS, BOD₅ and COD) from the wastewater. Due to the limited oxygen transfer inside the wetland, the removal of nutrients (especially nitrogen) is limited, however, HF wetlands remove the nitrates in the wastewater.

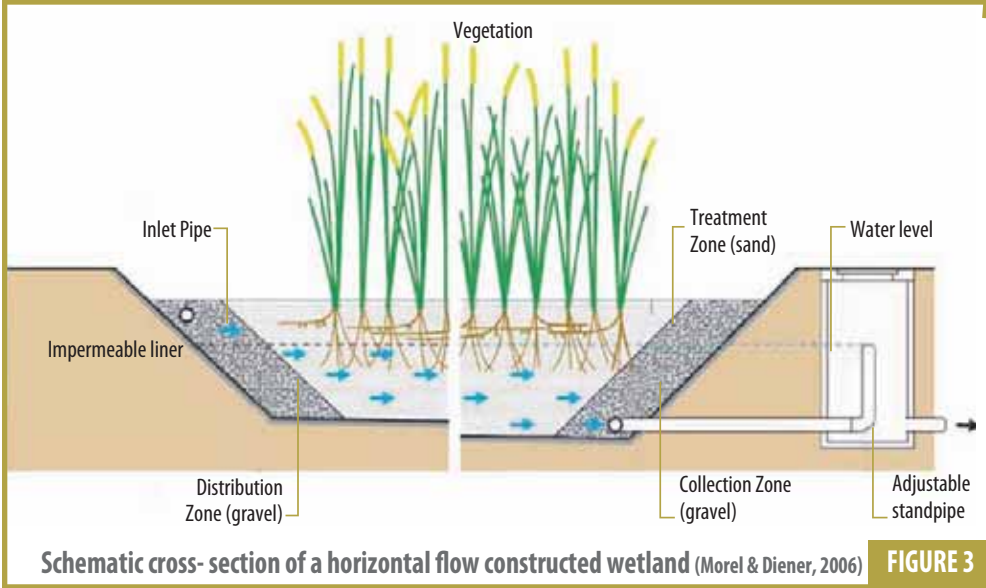

3.2 Vertical flow (VF)

VF constructed wetland comprises a flat bed of sand/gravel topped with sand/gravel and vegetation (Figure 4). Wastewater is fed from the top and then gradually percolates down through the bed and is collected by a drainage network at the base.

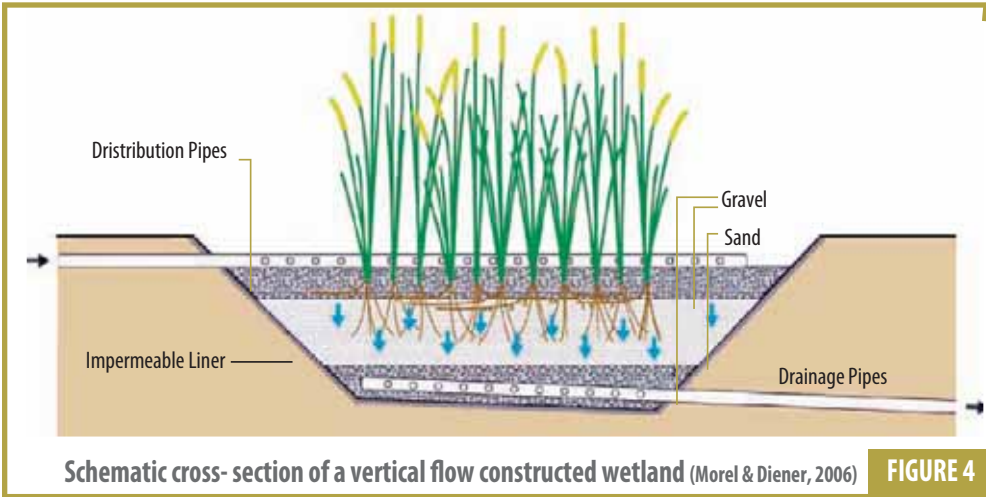

VF wetlands are fed intermittently in a large batch flooding the surface. The liquid gradually drains down through the bed and is collected by a drainage network at the base. The bed drains completely free and it allows air to refill the bed. The next dose of liquid traps this air and this together with aeration caused by the rapid dosing onto the bed leads to good oxygen transfer and hence the ability to nitrify. The oxygen diffusion from the air created by the intermittent dosing system contributes much more to the filtration bed oxygenation as compared to oxygen transfer through plant. Platzer (1998) showed that the intermittent dosing system has a potential oxygen transfer of 23 to 64 g O₂.m⁻².d⁻¹ whereas Brix (1997) showed that the oxygen transfer through plant (common reed species) has a potential oxygen transfer of 2 g O₂.m⁻².d⁻¹ to the root zone, which mainly is utilized by the roots and rhizomes themselves.

The latest generation of constructed wetlands has been developed as vertical flow system with intermittent loading. The reason for growing interest in using vertical flow systems are:

- They have much greater oxygen transfer capacity resulting in good nitrification;
- They are considerably smaller than HF system,
- They can efficiently remove BOD₅, COD and pathogens.

3.3 Hybrid

HF wetland is approved well to remove BOD₅ and TSS for secondary wastewater treatment but not for nitrification due to the limited oxygen transfer capacity. As a result there has been a growing interest in VF wetland because they have a much greater oxygen transfer capacity and considerably less area requirement than HF. But VF wetlands also have some limitation like less efficient in solids removal and can become clogged if the media selection is not correct. Due to these reasons, there has been a growing interest in combined (hybrid) wetlands. In these systems, the advantages and disadvantages of the HF and VF can be combined to complement each other.

Depending on the purpose, hybrid wetlands could be either HF wetland followed by VF wetland or VF wetland followed by HF wetland.

how does a constructed wetland function

A **CONSTRUCTED** wetland is a complex assemblage of wastewater, substrate, vegetation and an array of microorganisms (most importantly bacteria). Vegetation plays a vital role in the wetlands as they provide surfaces and a suitable environment for microbial growth and filtration. Pollutants are removed within the wetlands by several complex physical, chemical and biological processes as depicted in Figure 5.

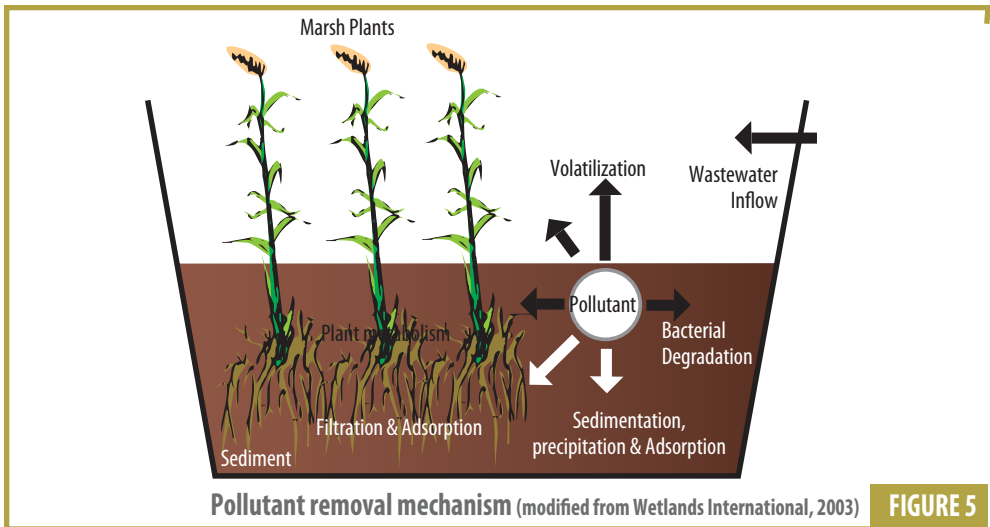

The pollutant removal mechanisms in constructed wetland are presented in Table 2.

TABLE 2 Pollutant Removal Mechanisms in Constructed Wetlands (Cooper *et al.*, 1996)

WASTEWATER CONSTITUENTS	REMOVAL MECHANISM
Suspended Solids	<ul style="list-style-type: none"> • Sedimentation • Filtration
Soluble organics	<ul style="list-style-type: none"> • Aerobic microbial degradation • Anaerobic microbial degradation
Phosphorous	<ul style="list-style-type: none"> • Matrix sorption • Plant uptake
Nitrogen	<ul style="list-style-type: none"> • Ammonification followed by microbial nitrification • Denitrification • Plant uptake • Matrix adsorption • Ammonia volatilization (mostly in SF system)
Metals	<ul style="list-style-type: none"> • Adsorption and cation exchange • Complexation • Precipitation • Plant uptake • Microbial Oxidation /reduction
Pathogens	<ul style="list-style-type: none"> • Sedimentation • Filtration • Natural die – off • Predation • UV irradiation (SF system) • Excretion of antibiotics from roots of macrophytes

Settleable and suspended solids that are not removed in the primary treatment are effectively removed in the wetland by filtration and sedimentation. Particles settle into stagnant micropockets or are strained by flow constrictions.

Attached and suspended microbial growth is responsible for the removal of soluble organic compounds, which are degraded biologically both aerobically (in presence of dissolved oxygen) as well as anaerobically (in absence of dissolved oxygen). The oxygen required for aerobic degradation is supplied directly from the atmosphere by diffusion or oxygen leakage from the vegetation roots into the rhizosphere, however, the oxygen transfer from the roots is negligible (Figure 6).

The mechanisms for phosphorus removal in constructed wetlands are adsorption, complexation and precipitation, storage, plant uptake and biotic assimilation (Watson *et al.*, 1989).

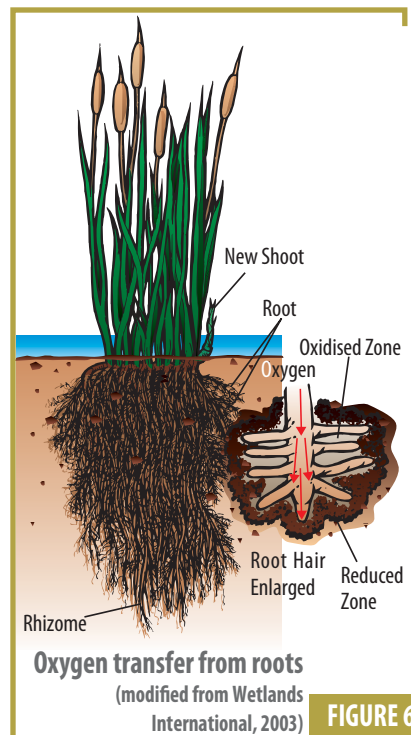
**FIGURE 6**

The removal mechanisms for nitrogen in constructed wetlands are manifold and include volatilization, ammonification, nitrification/denitrification, plant uptake and matrix adsorption (Figure 7). The major removal mechanism in most of the constructed wetlands is microbial nitrification/denitrification. Ammonia is oxidized to nitrate by nitrifying bacteria in aerobic zones. Nitrates are converted to dinitrogen gas by denitrifying bacteria in anoxic and anaerobic zones.

The process of metal removal in wetlands include sedimentation, filtration, adsorption, complexation, precipitation, cation exchange, plant uptake and microbially-mediated reactions especially oxidation (Watson *et al.*, 1989). Adsorption involves the binding of metal ions to the plant or matrix surface, whereas the presence of bacteria causes the precipitation of metal oxides and sulphides within the wetland. Some wetland species have a well-established ability for direct uptake of metals.

Pathogens are removed in wetland during the passage of wastewater through the system mainly by sedimentation, filtration and adsorption by biomass. Once these organisms are entrapped within the system, their numbers decrease rapidly, mainly by the processes of natural die-off and predation (Cooper *et al.*, 1996).

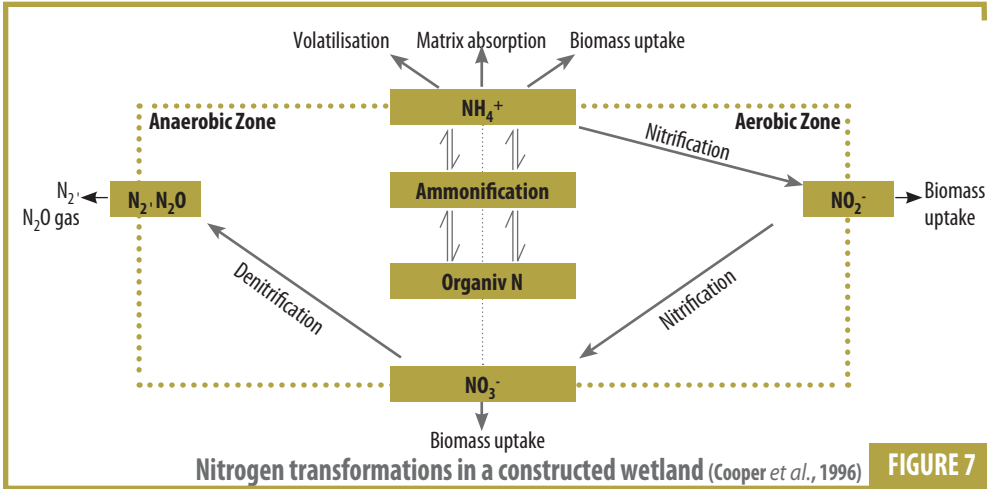

design of constructed wetland

BEFORE designing a constructed wetland, it should be borne in mind that the substrate of the wetland can be rapidly filled up with debris, grit, and solids from raw wastewater if these materials are not removed prior to the wetland. Therefore, a minimum preliminary/primary treatment should be provided to remove the settleable solids. However, some systems in France have avoided the primary treatment units and used staged vertical flow constructed wetlands, that are operated in parallel, instead (Molle *et al.*, 2004). These systems are out of the scope of this manual. Please refer to the research paper “How to treat raw sewage with constructed wetlands: An overview of the French Systems” presented as Annex–A of this manual.

5.1 Preliminary treatment

Preliminary treatment mainly separates the coarsely dispersed solids out of the liquid phase. The preliminary treatment prepares wastewater influent for further treatment in wetland by reducing or removing problem wastewater characteristic that could otherwise impede operation or unduly increase maintenance of the wetland and pumps (if any). The typical problem characteristics include large solids and rags; grit; odours etc.

The preliminary treatment of wastewater comprises of mainly screen and grit chamber. A screen is a device with openings, generally of uniform size, that is used to retain solids found in the influent wastewater to the treatment plant, which removes coarse materials from the wastewater. Grit chamber remove grit, consisting of sand, gravel, or other heavy sold materials that have specific gravities much greater than those of the organic solids in the wastewater.

(The Reader is recommended to follow standard text books for preliminary treatment of wastewater.)

5.2 Primary treatment

Primary treatment separates the suspended matter by physical operations mainly sedimentation. Raw wastewater contains suspended particulate heavier than water; these particles tend to settle by gravity under quiescent conditions. Primary treatment reduces suspended solids, organic load to the wetland and also equalises raw wastewater quality and flow to a limited degree.

5.2.1 Septic Tank

The septic tank is the most common primary treatment used in small-scale constructed wetland worldwide. A two-compartment septic tank will remove more solids than a single compartment tank (Loudon *et al.*, 2005). Figure 8 depicts a schematic cross-section of a typical double-compartment septic tank.

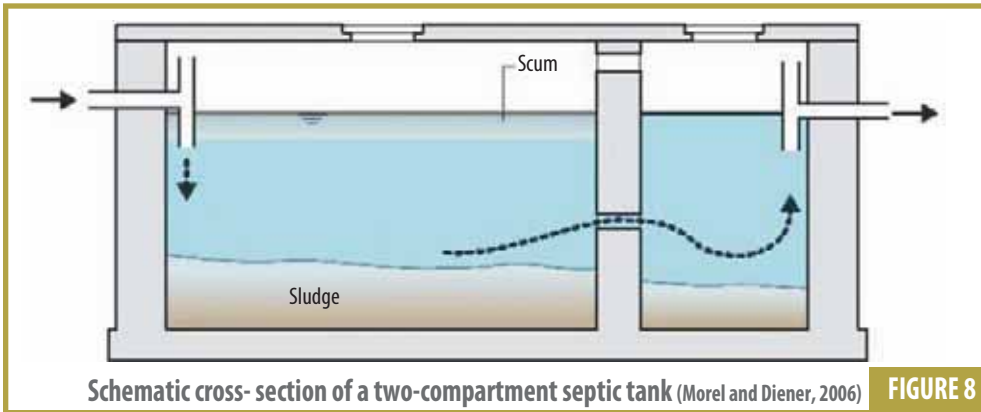

Septic tanks will generally need to be desludged, otherwise they produce very poor effluents with high suspended solids content, which can be detrimental to the constructed wetland (clogging of beds). To ensure continuous effective operation, the accumulated material must therefore be emptied periodically. This should take place when sludge and scum accumulation exceeds 30 percent of the tank’s liquid volume. The basic design criteria for a two-chambered septic tank is shown in Table 3.

Table 3 Basic design criteria for two-compartment septic tank

Hydraulic retention time	> 12 hours at maximum sludge depth and scum accumulation
Sludge accumulation rate	Depending on TSS removal rate and wastewater flow (70 – 100 litres/person/year)
Sludge and scum accumulation volume	Sludge accumulation rate multiplied by sludge accumulation rate
Desludging interval	> 1 year
Volume of first compartment	Two-third of the entire tank volume

Further information on septic tank design is available from Mara D. (1996), Crites and Tchobanoglous (1998), Sasse L. (1998) or any other standard references.

EXAMPLE

The example presented here is a general case. Let us calculate the sizing of a two-chambered septic tank for a population of 400 with specific wastewater flow of 80 litres per person per day.

- Average volume of wastewater (Q) = $400 \times 80 / 1000 = 32 \text{ m}^3/\text{d}$
- Hydraulic Retention time (HRT) = 1.5 day = 36 hours (assumed)
- Required volume of septic tank = $Q \times \text{HRT} = 32 \times 1.5 = 48 \text{ m}^3$
- Volume of 1st compartment = $2/3$ of required volume = $2/3 \times 48 = 32 \text{ m}^3$
- Volume of 2nd compartment = $1/3$ of required volume = $1/3 \times 48 = 16 \text{ m}^3$
- Depth of septic tank = 2 m (assumed)
- Width of septic tank = 4 m (assumed)

Then,

- Length of 1st compartment = $\text{Volume}/(\text{Depth} \times \text{Width}) = 32/(1.7 \times 4) = 4.7 \text{ m}$
- Length of 2nd compartment = $\text{Volume}/(\text{Depth} \times \text{Width}) = 16/(1.7 \times 4) = 2.35 \text{ m}$

** Please note that the depth of septic tank is taken as 1.7 m after deducting a free board of 0.3 m*

Check the HRT after sludge accumulation:

- Sludge accumulation rate = 70 litres/person/year
- Desludging interval = 1 year
- Sludge volume = $\text{sludge accumulation rate} \times \text{number of users} \times \text{desludging interval} = (70 \times 400 \times 1)/1000 = 28 \text{ m}^3$
- Available volume for wastewater in septic tank = $\text{Total volume} - \text{sludge volume} = 48 - 28 = 20 \text{ m}^3$
- HRT after sludge accumulation = $\text{Available volume for wastewater in septic tank}/\text{Average volume of wastewater} = 20/32 = 0.625 \text{ days} = 15 \text{ hours}$ (Since HRT > 12 hours, the design is OK)

5.2.2 Anaerobic Baffle Reactor (Improved septic tank)

In recent years, anaerobic baffle reactor (improved septic tank) designs have been developed to enhance removal efficiencies of solids and organic pollutants. The basic principle of such systems is to increase contact between the entering wastewater and the active biomass in the accumulated sludge. This is achieved by inserting baffles into the tank and forcing the wastewater to flow under and over the baffles as the wastewater passes from inlet to outlet. Wastewater flowing from bottom to top passes through the settled sludge and enables contact between wastewater and biomass.

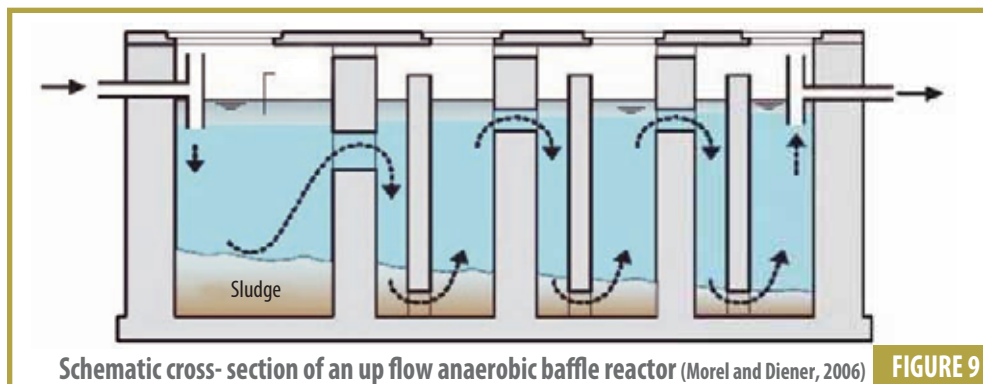

FIGURE 9

The basic design criteria for an anaerobic baffle reactor are shown in Table 4.

Table 4 Basic design criteria for an anaerobic baffle reactor

Hydraulic retention time	> 24 hours at maximum sludge depth and scum accumulation
Sludge accumulation rate	Depending on TSS removal rate and wastewater flow (70 – 100 litres/person/year)
Sludge and scum accumulation volume	Sludge accumulation rate multiplied by sludge accumulation rate
Desludging interval	> 1 year
Number of upflow chambers	> 2
Maximum upflow velocity	1.4 – 2 m/h

Further information on anaerobic baffle reactor design is available from Sasse (1998), Wanasen (2003), Foxon *et al.*, (2004) etc.

5.3 Sizing of the wetland

5.3.1 Sizing based on equation

The wetland might be sized based on the equation proposed by Kickuth:

$$A_h = \frac{Q_d (\ln C_i - \ln C_e)}{K_{BOD}}$$

- A_h = Surface area of bed (m²)
- Q_d = average daily flow rate of sewage (m³/d)
- C_i = influent BOD₅ concentration (mg/l)
- C_e = effluent BOD₅ concentration (mg/l)
- K_{BOD} = rate constant (m/d)

K_{BOD} is determined from the expression $K_T dn$, where,

- $K_T = K_{20} (1.06)^{(T-20)}$
- K_{20} = rate constant at 20 °C (d⁻¹)
- T = operational temperature of system (°C)
- d = depth of water column (m)
- n = porosity of the substrate medium (percentage expressed as fraction)

K_{BOD} is temperature dependent and the BOD degradation rate generally increases about 10 % per °C. Thus, the reaction rate constant for BOD degradation is expected to be higher during summer than winter. It has also been reported that the K_{BOD} increases with the age of the system.

a) K_{BOD} for HF wetland

Figure 10 shows K_{BOD} for a HF wetland. The graph has been plotted based on the above equation for temperatures ranging from 10 °C to 25 °C. The depth of HF wetland has been taken as 40 cm and the porosity of the substrate as 40%. The value of K_{20} has been taken as 1.1 d⁻¹.

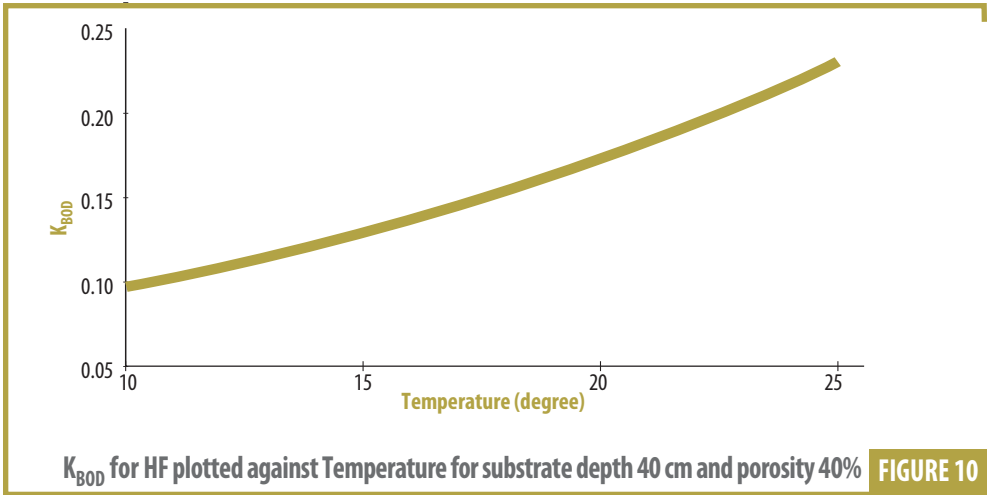

b) K_{BOD} for VF wetland

Figure 11 shows K_{BOD} for a VF wetland. The graph has been plotted based on the same equation as for HF wetland for temperatures ranging from 10 °C to 25 °C. The depth of VF wetland has been taken as 70 cm and the porosity of the substrate as 30%. The value of K_{20} has been taken as 1.1 d⁻¹.

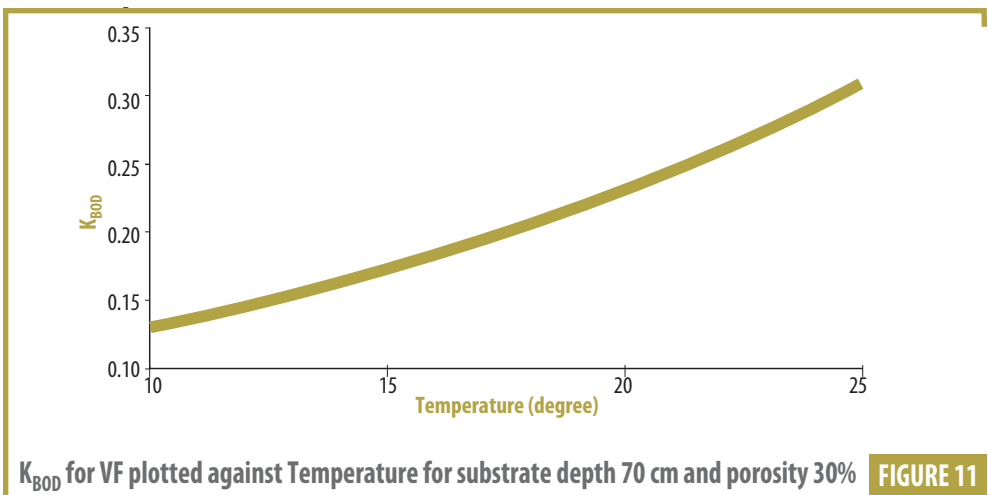

5.3.2 Sizing based on specific area requirement per Population Equivalent (PE)

The specific area requirement per PE holds true where there is uniformity in the specific wastewater quantity and quality. In general, the rules of thumb suggested by several works can be served as a safe bed (depending on the climatic conditions). However the investment costs tend to be higher due to conservative aspects of this approach.

Specific area requirement for HF and VF constructed wetland has been calculated for various specific wastewater discharges for a certain population. The BOD contribution has been taken as 40 g BOD/pe.d, 30% BOD load is reduced in the primary treatment and the effluent concentration of BOD is taken as 30 mg/l. The K_{BOD} for HF and VF wetlands are taken as 0.15 and 0.20 respectively. It is seen that a specific area requirement of 1 – 2 m²/pe would be required of HF constructed wetlands where as a specific area of 0.8 – 1.5 m²/pe for the VF wetland.

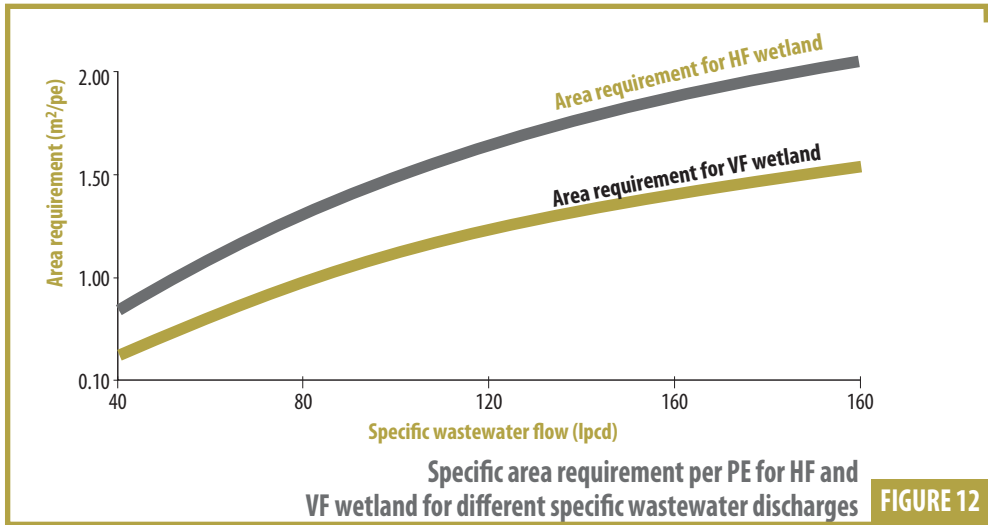

Taking into considerations of the cases in Nepal, it is to be noted that the specific area requirement presented in the graph is less than the specific area requirement given in various literatures because the K_{BOD} used in the literatures are lower and the specific wastewater discharges are high.

EXAMPLE

The example presented here is a general case. The local circumstances and standards needs to be taken into account by the designer. Let us calculate the sizing of a constructed wetland for a population of 400 with specific wastewater flow of 80 litres per person per day.

- Average volume of wastewater (Q) = $400 \times 80 / 1000 = 32 \text{ m}^3/\text{d}$

To determine the influent BOD_5 concentration, the wastewater sample should be analyzed in an accredited laboratory. In the absence of a laboratory, the concentration can be calculated as below:

- BOD_5 contribution = $40 \text{ g BOD}_5/\text{pe.d}$
- BOD_5 concentration = $40 \times 1000/80 = 500 \text{ mg/l}$
- Let us assume that 30% BOD_5 is removed by the primary treatment unit, then the influent BOD_5 concentration to the wetland (C_i) = 350 mg/l
- Effluent BOD_5 concentration (C_e) = 30 mg/l
- $K_{\text{BOD}} = 0.15 \text{ m/d}$ for HF wetland and 0.2 m/d for VF wetland

Substituting the values in the equation below:

$$A = \frac{Q_d (\ln C_i - \ln C_e)}{K_{\text{BOD}}}$$

- Area for HF wetland = 524.10 m^2
- Specific area per PE for HF wetland = 1.31 m^2
- Area for VF wetland = 393.08 m^2
- Specific area per PE for VF wetland = 0.98 m^2

5.4 Depth

In general, the depth of substrate in a subsurface flow constructed wetland is restricted to approximately the rooting depth of plants so that the plants are in contact with the flowing water and have an effect on treatment. However, Hydraulic Retention Time – HRT (time the wastewater is retained in the wetland) is to be considered in the selection of the depth of the wetland.

5.4.1 HF wetland

Most HF wetlands in Europe provide a bed depth of 60 cm (Cooper *et al.*, 1996). In the United States, HF wetlands have commonly been designed with beds 30 cm to 45 cm deep (Steiner and Watson, 1993). An experimental study carried out in Spain showed that shallow HF wetlands with an average depth of 27 cm were more effective than deep HF wetlands with an average water depth of 50 cm. (Garcia *et al.*, 2004).

It is recommended to use an average depth of 40 cm taking into considerations of the precipitation, which could cause surface flow.

5.4.2 VF wetland

Generally, VF systems are built with larger depths compared to HF systems. Most VF systems in UK are built 50 – 80 cm deep (Cooper *et al.*, 1996). In contrast to that, depth greater than 80 cm is recommended in Germany (ATV, 1998). Similarly, in Austria a depth of 95 cm is recommended (ÖNORM 1997). A minimum of 100 cm depth is recommended in Denmark (Brix, 2004). The VF systems in Nepal were also built about 100 cm deep but nowadays shallower depths are being practiced.

In a subtropical climate, it is possible to increase the applied loading rates above guidelines issued in Central Europe and achieve nitrification in VF system. The average results by vertical beds of 75 cm depth showed better performance in comparison with vertical beds of 45 cm depth (Philippi *et al.*, 2004).

It is recommended to use substrate depth of 70 cm, which can provide adequate nitrification in addition to the organic pollutants removal.

5.5 Bed cross section area (only for HF wetland)

Dimensioning of the bed is derived from Darcy's law and should provide subsurface flow through the gravel under average flow conditions. Two important assumptions have been made in applying the formula:

- hydraulic gradient can be used in place of slope, and
- the hydraulic conductivity will stabilize at 10^{-3} m/s in the established wetland.

The equation is:

$$A_c = Q_s / K_f (dH/ds)$$

- A_c = Cross sectional area of the bed (m^2)
- Q_s = average flow (m^3/s)
- K_f = hydraulic conductivity of the fully developed bed (m/s)
- dH/ds = slope of bottom of the bed (m/m)

For graded gravels a value of K_f of 1×10^{-3} to 3×10^{-3} m/s is normally chosen. In most cases, dH/ds of 1% is used.

There is no hard and fast rule on the optimum width of the wetland, however, it is recommended that if the width of the wetland is more than 15 m, the wetland cell should be partitioned to avoid short circuiting of wastewater inside the wetland. It should also be kept in mind that it is better to use at least two parallel cells instead of a single wetland cell for the ease in operation and maintenance of the wetland.

EXAMPLE

Let us find the bed cross sectional area required for the HF wetland that was calculated in section 5.3

- $Q_s = 32 \text{ m}^3/\text{d} = 0.00037 \text{ m}^3/\text{s}$
- $K_f = 2 \times 10^{-3} \text{ m/s}$
- $dH/ds = 0.01$

Substituting the values in the above equation,

- $A_c = 18.52 \text{ m}^2$

Considering the depth of the wetland as 0.4 m, the width of the wetland would be 46.30 m. Length of the wetland = Plan area/width = $524.1/46.3 = 11.3 \text{ m}$

It is recommended that if the width of the wetland is greater than 15 m, the wetland cell should be partitioned. Now let us take 3 wetlands in parallel, then

- $Q_s = 0.00012 \text{ m}^3/\text{s}$
- $K_f = 2 \times 10^{-3} \text{ m/s}$
- $dH/ds = 0.01$

Substituting the values in the above equation,

- $A_c = 6.17 \text{ m}^2$

Considering the depth of the wetland as 0.4 m, the width of the wetland would be 15.43 m. Let us provide a width of 15 m. Length of the wetland = Plan area/width/number of wetlands = $524.1/15/3 = 11.6 \text{ m}$

In VF wetlands, since the flow is vertical, the width and cross-sectional area of VF beds are not set by a requirement to keep the flow below surface and prevent surface flow.

5.6 Media selection

The media perform several functions. They:

- are rooting material for vegetation,
- help to evenly distribute/collect flow at inlet/outlet,
- provide surface area for microbial growth, and
- filter and trap particles.

Very small particles have very low hydraulic conductivity and create surface flow. Very large particles have high conductivity, but have little wetted surface area per unit volume of microbial habitat. Large and angular medium is inimical to root propagation. The compromise is for intermediate-sized materials generally characterized as gravels. It is recommended that the gravels are washed because this removes fines that could block the void spaces.

5.6.1 HF wetland

It is reported that the diameter size of media used in HF wetlands varies from 0.2 mm to 30 mm (ÖNORM B 2505, 1996, Vymazal, 1997, GFA, 1998, EC/EWPCA, 1990, U.S. EPA, 1988, Steiner and Watson, 1993, U.S. EPA, 1993, Reed *et al.*, 1995, U.S. EPA, 2000).

It is recommended that the media in the inlet and outlet zones should be between 40 and 80 mm in diameter to minimize clogging and should extend from the top to the bottom of the system. For the treatment zone, there does not appear to be a clear advantage in pollutant removal with different sized media in the 10 to 60 mm range (U.S. EPA, 2000). Figure 13 shows the recommended substrate sizes, which uses 40 – 80 mm media at the inlet/outlet zones and 5 – 20 mm at the treatment zone.

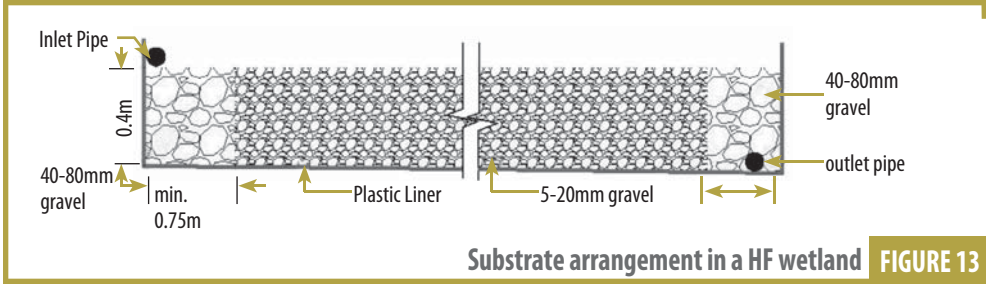

5.6.2 VF wetland

The substrate properties, d_{10} (effective grain size), d_{60} and the uniformity coefficient (the quotient between d_{60} and d_{10}) are the important characteristics in the selection of the substrate. There is not one uniform standard substrate design for the construction of VF wetland. Various literatures reports effective grain size should be $0.2 < d_{10} < 1.2$ mm, uniformity coefficient $3 < d_{60}/d_{10} < 6$ and hydraulic conductivity K_f 10^{-3} to 10^{-4} m/s (Reed *et al.*, 1990, Vymazal *et al.*, 1998, GFA, 1998, Liénard *et al.*, 2000, Brix, H., 2004, Korkusuz, E.A., 2005). The filter media used at Dhulikhel Hospital had $d_{10} = 0.4$ mm and $d_{60}/d_{10} = 1.5$ (Shrestha R.R., 1999).

The rate of decrease in permeability for similar SS influent characteristics is highest for porous media with smaller pore sizes. Compared to the gravel, the sands show a relatively more rapid reduction in their permeability due to effects of sediment accumulation at the surface of the sands. However, the depth of clogging is higher for larger particle sizes (Walker, 2006).

It is recommended to use sand (0 – 4 mm) as main substrate with $d_{10} > 0.3$ mm, $d_{60}/d_{10} < 4$ and having permeability of 10^{-3} to 10^{-4} m/s. The substrate shall be arranged as shown in Figure 14.

5.7 Bed slope

The top surface of the media should be level or nearly level for easier planting and routine maintenance. Theoretically, the bottom slope should match the slope of the water level to maintain a uniform water depth throughout the bed. A practical approach is to uniformly

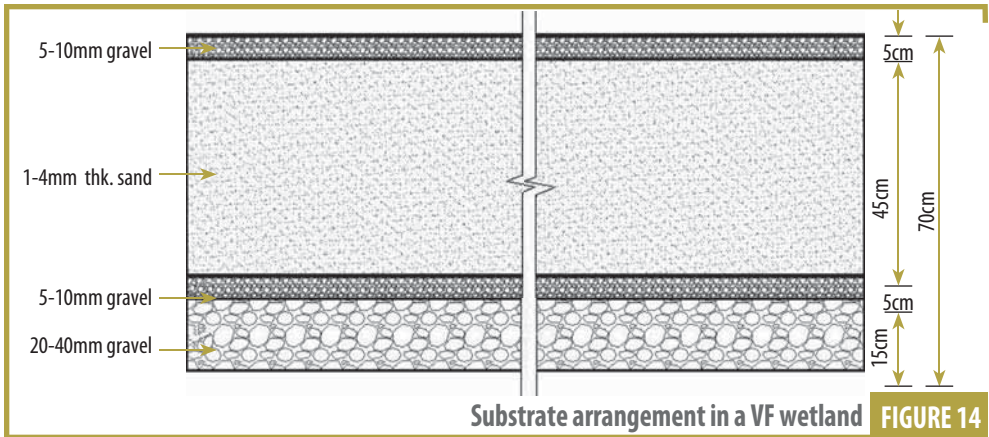

slope the bottom along the direction of flow from inlet to outlet to allow for easy draining when maintenance is required. No research has been done to determine an optimum slope, but a slope of 0.5 to 1% is recommended for ease of construction and proper draining.

5.8 Sealing of the bed

Subsurface flow wetlands providing secondary treatment should be lined to prevent direct contact between the wastewater and groundwater. Liners used for wetlands are the same as those typically used for ponds.

Native soils may be used to seal the wetlands if they have sufficiently high clay content to achieve the necessary permeability. The thickness of the linings depends on the permeability of the soil. The advice given in the European Guidelines (Cooper, 1990) was that if the local soil had a hydraulic conductivity of 10^{-8} m/s or less then it is likely that it contained high clay content and could be “puddled” to provide adequate sealing for the bed. As a general guide, the following interpretations may be placed on values obtained for the in situ coefficient of permeability:

- **$k > 10^{-6}$ m/s:** the soil is too permeable and the wetlands must be lined;
- **$k > 10^{-7}$ m/s:** some seepage may occur but not sufficiently to prevent the wetlands from having submerged condition;
- **$k < 10^{-8}$ m/s:** the wetlands will seal naturally;
- **$k < 10^{-9}$ m/s:** there is no risk of groundwater contamination (if $k > 10^{-9}$ m/s and the groundwater is used for potable supplies, further detailed hydrogeological studies may be required).

The soil could be mixed with ordinary Portland cement (8 kg/m^2) to decrease the soil permeability and compacted to seal the wetlands. Bentonite mixed with the native soils and compacted has been used in the developed countries.

Other synthetic liners include:

- Polyvinyl chloride (PVC)
- Polyethylene (PE)
- Polypropylene

Liners should be selected based on its availability and cost effectiveness. Preparation of the subgrade under the liner is crucial for successful liner installation. The finished subgrade should be free from materials that might puncture the liner.

5.9 Inlet and outlet structures

Inlet and outlet structures distribute the flow into the wetland, control the flow path through the wetland, and control the water depth. Multiple inlets and outlets spaced across either end of the wetland are essential to ensure uniform influent distribution into and flow through the wetland. These structures help to prevent “dead zones” where exchange of water is poor, resulting in wastewater detention times that can be much less than the theoretical detention times.

The inlet structure must be designed to minimize the potential for short-circuiting and clogging in the media, and maximize even flow distribution, whereas, the outlet structure must be designed to minimize the potential for short-circuiting, to maximize even flow collection, and to allow the operator to vary the operating water level and drain the bed.

5.9.1 Inlets

Inlet structures at subsurface wetlands include surface and subsurface manifolds such as a perforated pipe, open trenches perpendicular to the direction of the flow etc. A single inlet would not be suitable for a wide wetland cell because it would not be possible to achieve uniform flow across the cell. In general, perforated or slotted manifolds running the entire wetland width typically are used for the inlets. Sizes of the manifolds, orifice diameters, and spacing are a function of the design flow rate.

Where possible, the inlet manifold should be installed in an exposed position to allow access by the operator for flow adjustment and maintenance. A subsurface manifold avoids the build-up of algal slimes and the consequent clogging that can occur next to surface manifolds, but it is difficult to adjust and maintain.

a) HF wetland

In HF wetlands, the aim is to get even distribution across the full cross-sectional area of the inlet end of the bed. In most beds, the flow is distributed onto a stone inlet zone, which comprises of large graded stones. The examples of HF inlet designs are shown in Figure 15.

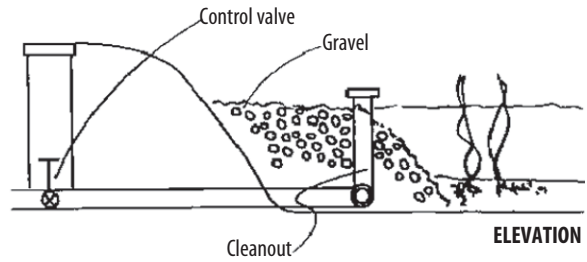
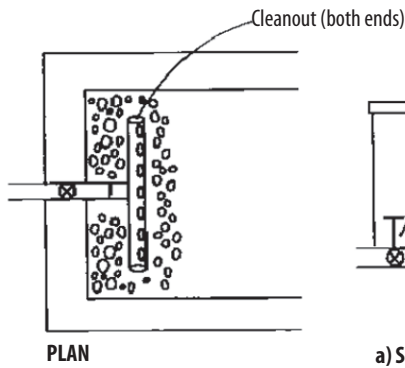

a) Submerged perforated pipe

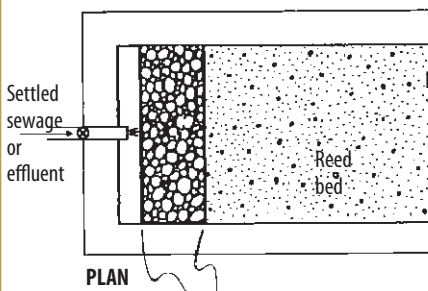

b) Gabion feed

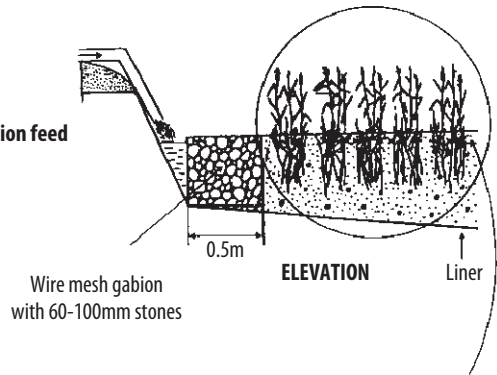

Wire mesh gabions

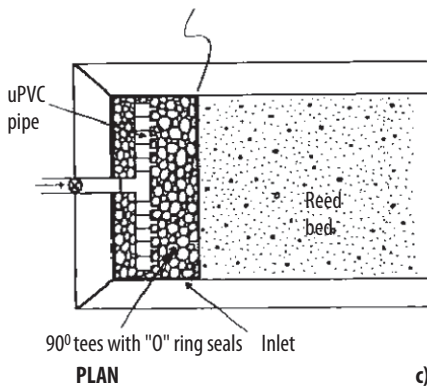

c) Swivel tee

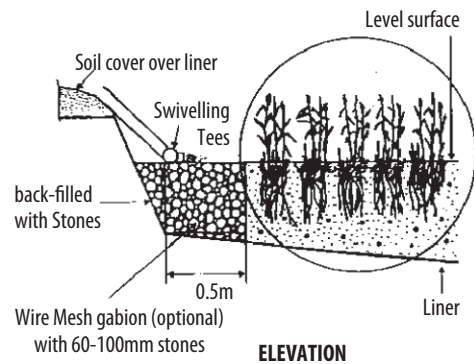

Examples of HF CW inlet designs (U.S. EPA, 2000) **FIGURE 15**

Plates 1 to 6 show different types of HF inlet systems.



Perforated pipe inlet

PLATE 1



Slotted pipe inlet

PLATE 2



Channel inlet
(Cooper *et al.*, 1996)

PLATE 3

Channel inlet
– close up view
(Cooper *et al.*, 1996)



PLATE 4

Gabion inlet
(Cooper *et al.*, 1996)



PLATE 5

Submerged pipe
inlet – riser pipes
with V-notches
(Cooper *et al.*, 1996)



PLATE 6

b) VF wetland

In VF wetlands, it is essential to get an even distribution over the whole bed area. Inlet structures for VF wetland comprises of an intermittent feeding tank with distribution network. Plate 7 and 8 shows the functioning of a hydromechanical siphon used for intermittent feeding. In this system feeding of water into the beds is maintained by the water level. When the water level reaches certain height in the tank, a stopper stops the bucket to move up. Water level rises and fills the bucket. The bucket gets heavier and sinks down then the water flushes into the bed from the feeding tank. When certain amount of water is flushed into the bed, water stops flowing into the bed. Water inside the bucket also will sucked out due to a pressure build up by siphon then it will float again inside the tank till water refills again.

Some wetlands have used a network of pipes with downward pointing holes. The pipe ends should be raised so that air can pass through during flushing as well as to achieve equal distribution of the wastewater. Others have used troughs or gutters with overflow from each side. The examples of VF inlet designs are shown in Plates 9 to 11.



Feeding tank and mechanism - Optimum water level in the tank, just going to fill in the bucket (Shrestha, R.R., 1999)

PLATE 7



Feeding tank and mechanism - Bucket sinks down and water flushes into the bed (Shrestha R.R., 1999)

PLATE 8

Pipe network inlet with main pipe in the centre

PLATE 9



Pipe network inlet with main pipe in the edge

PLATE 10



Channel distributor
(Cooper *et al.*, 1996)

PLATE 11



5.9.2 Outlet

Outlet structures help to control uniform flow through the wetland as well as the operating depth. The design of subsurface flow wetlands should allow controlled flooding to 15 cm to foster desirable plant growth and to control weeds. The use of an adjustable outlet, which is recommended to maintain an adequate hydraulic gradient in the bed, can also have significant benefits in operating and maintaining the wetland. A perforated subsurface manifold connected to an adjustable outlet offers the maximum flexibility and reliability as the outlet devices for subsurface flow wetlands. This can be an adjustable weir or gate, a series of stop logs, or a swiveling elbow. Figure 16 and Plates 12 to 14 show various types of outlets.

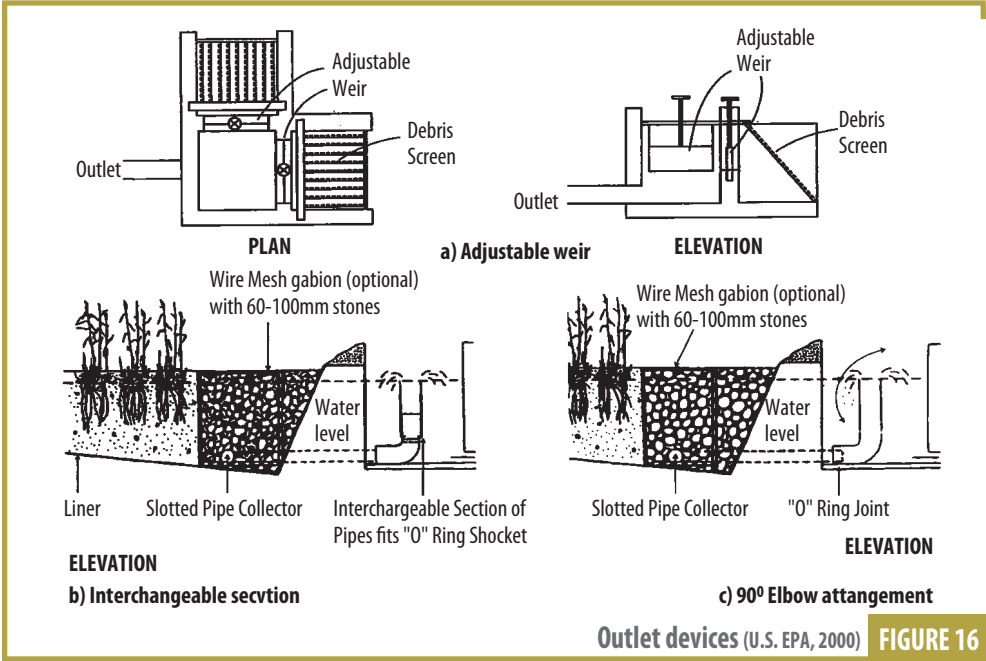

**Elbow outlet
PLATE 12**

Swivelling elbow
outlet
(Cooper *et al.*, 1996)

PLATE 13



Flexible pipe outlet
(Cooper *et al.*, 1996)

PLATE 14



In HF systems, most systems have a perforated drain pipe enclosed in a 0.5 m wide drainage zone filled with large graded stones. This leads to a sump where the water level is controlled by either a swivelling elbow or a socketed pipe. For small systems, a cheaper alternative is the use of flexible plastic pipe which can be held in position by a chain or rope.

In VF systems, the collection system may consist of a network of drainage pipes surrounded by large stones. The drainage pipe will lead to a collection sump which will allow the vertical bed to completely drain.

5.10 Vegetation

Vegetation and its litter are necessary for successful performance of constructed wetlands and contribute aesthetically to the appearance. The vegetation to be planted in constructed

wetlands should fulfill the following criteria:

- application of locally dominating macrophyte species;
- deep root penetration, strong rhizomes and massive fibrous root;
- considerable biomass or stem densities to achieve maximum translocation of water and assimilation of nutrients;
- maximum surface area for microbial populations;
- efficient oxygen transport into root zone to facilitate oxidation of reduced toxic metals and support a large rhizosphere.

Plates 15 and 16 show two species, *Phragmites* sp. and *Typha* sp., widely used vegetation in constructed wetlands. *Phragmites karka* and *P. australis* (Common Reed) is one of the most productive, wide spread and variable wetland species in the world. Due to its climatic tolerance and rapid growth, it is the predominant species used in constructed wetlands.



Phragmites karka
(common reed)

PLATE 15



Cattail - typha angustifolia
(Wetlands International, 2003)

PLATE 16

construction of constructed wetland

CONSTRUCTION of constructed wetland primarily involves basin construction (common earth moving, excavating, leveling, compacting and construction of berms/walls), lining of the basin, filling the basin with substrates, constructing inlet and outlet structures and planting vegetation. The establishment of vegetation is unique to other construction activities. It is the intent of this section to provide guidance on these special and unique aspects of wetland construction.

6.1 Basin construction

Standard procedures and techniques used in civil engineering are applied for the basin construction, which include earthwork in excavation, leveling and compaction. It is desirable to balance the cut and fill on the site to avoid the need for remote borrow pits or soil disposal. If agronomic-quality topsoil exists on the site, it should be stripped and stockpiled. Uniform compaction of the subgrade is important to protect the liner integrity from subsequent construction activity (i.e., liner placement, gravel placement etc.) and from stress when the wetland is filled. Most wetlands are graded level from side to side and either level or with a slight slope (about 1%) in the direction of flow. Berms (walls) should be constructed in conformance with standard geotechnical considerations. An adequate amount of freeboard should be provided to contain a given storm rainfall amount. Plates 17 to 21 show construction of basin.

6.2 Lining of the basin

Lining of the basin is required if the permeability of the soil is greater than 10^{-6} m/s. Liner should be selected based on its availability and cost. Proper care should be taken to prevent liner punctures during placement and subsequent construction activity. If the subgrade contains sharp stones, a layer of sand should be placed beneath the liner and levelled. Plate 22 shows plastic lining of the basin.

Small scale in-situ (field) method for the determination of permeability

The method fall into two groups: those that are used to determine the permeability above the water table and those that are below the water table.

Above the water table, the soil is not saturated. To measure the saturated hydraulic conductivity, one must therefore apply sufficient water to obtain near saturated conditions. These methods are called ‘infiltration methods’. Below the water table, the soil is saturated by definition. It then suffices to remove water from the soil, creating a sink, and to observe the flow rate of water into the sink together with the hydraulic head induced. These methods are called ‘extraction methods’.

Extraction method

A hole is bored into the soil to a certain depth below the water table. When the water in the hole reaches equilibrium with the ground water, part of it is removed. The ground water thus begins to seep into the hole and the rate at which it rises is measured. The hydraulic conductivity of the soil is computed with the following formula:

$$K = C \times (H_0 - H_t) / t$$

Where,

- K = hydraulic conductivity of the saturated soil (m/d)
- C = a factor depending on the depth of an impermeable layer below the bottom of the hole and average depth of the water level in the hole below the water table
- t = time elapsed since the first measurement of the level of the rising water in the hole
- H_t = depth of water level in the hole below reference level at time t (cm)
- $H_0 = H_t$ when t = 0

When $D > \frac{1}{2} D_2$, then

- $C = (4000 \times r / h') / ((20 + D_2 / r) \times (2 - h' / D_2))$

When $D = 0$, then

- $C = (3600 \times r / h') / ((10 + D_2 / r) \times (2 - h' / D_2))$

Infiltration method

A hole is bored into the soil to the required depth, the hole is filled with water, which is left to drain away freely. The hole is refilled with water several times until the soil around is

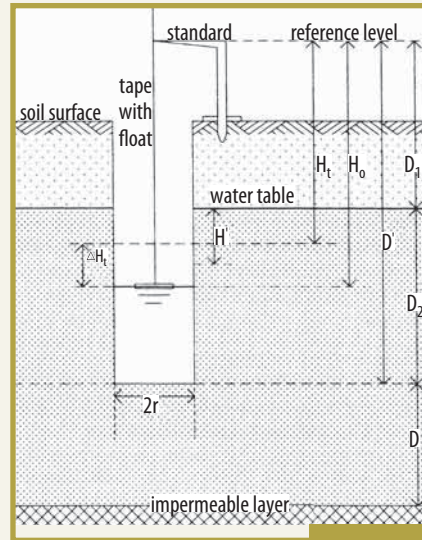

saturated over a considerable distance and infiltration (rate) has attained a more or less constant value. After the last refilling of the hole, the rate of drop of the water level in the hole is measured. The data ($h + \frac{1}{2}r$ and t) are then plotted on semi-log paper. The graph should yield a straight line. If the line is curved, continue to wet the soil until the graph shows the straight line. Now, with any two pairs of values of $h + \frac{1}{2}r$ and t , the K value can be calculated according to the following equation:

$$K = 1.15r ((\log(h_0 + \frac{1}{2}r) - \log(h_t + \frac{1}{2}r)) / (t - t_0))$$

Where,

- t = time since the start of measuring (s)
- h_t = the height of water column in the hole at time t (cm)
- $h_0 = h_t$ at time $t = 0$

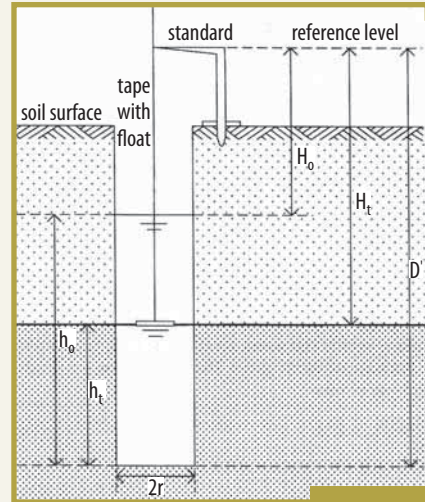

6.3 Substrate filling

Once liner has been placed in the basin, filling with substrates shall be commenced in conjunction with inlet/outlet arrangements. The substrate should be washed to eliminate soil and other fines that could block the void spaces, which contribute to substrate clogging. Rounded river substrate is recommended over sharp-edged crushed substrate because of the looser packing that the rounded substrate provides.

6.3.1 HF wetland

Before filling substrates, the partitioning of inlet/outlet zones must be done. Outlet arrangements should be addressed properly while filling the substrates. The substrate should be sieved and washed before filling the designed substrate sizes in the inlet/outlet zones and treatment zone. Plate 23 shows the filling of substrates in a HF wetland.

6.3.2 VF wetland

Before filling substrates in a VF wetland, the layers of different size of substrate to be filled should be properly marked inside the basin. The substrates should be properly washed to eliminate the undesired particles. Collection network at the base of the basin should be laid in accordance with the design prior to the filling of the substrates. Filling shall commence once the above mentioned activities have been completed. Since sand is the substrate for

the main treatment zone, the properties of sand should be analyzed in an accredited laboratory. Grain size analysis and determination of hydraulic conductivity should be performed. A typical grain size distribution of sand suitable for VF CWs is shown in Figure 17. In the absence of an accredited laboratory, the suitability of sand can be determined sand suitability test.

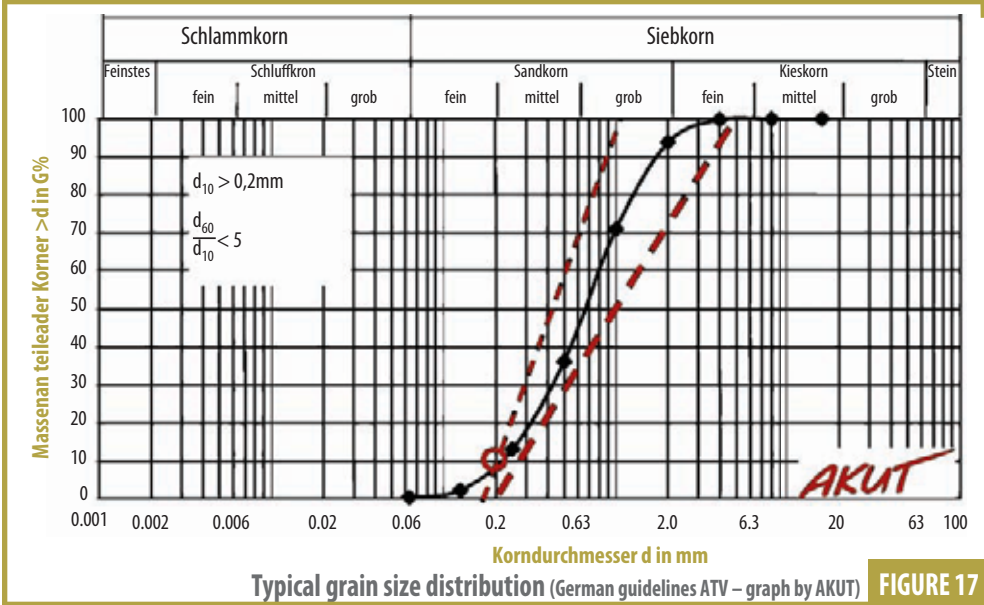

Sand suitability test

A 300 mm long length of 110 mm diameter PVC pipe is placed on a bed of pea gravel and filled with 200 mm of the sand to be tested as shown in Figure 18. The sand should be damp but not saturated. A small square of pan scourer or similar is placed on the sand surface to reduce disturbance by the water. Next 500 ml of tap water is poured into the tube quickly, but without disturbing the sand surface too much, and the time for it to drain completely is measured. As soon as it has passed through another 500 ml of water is added and again timed. This is repeated until the time taken levels off. The time can now be plotted as shown in Figure 19.

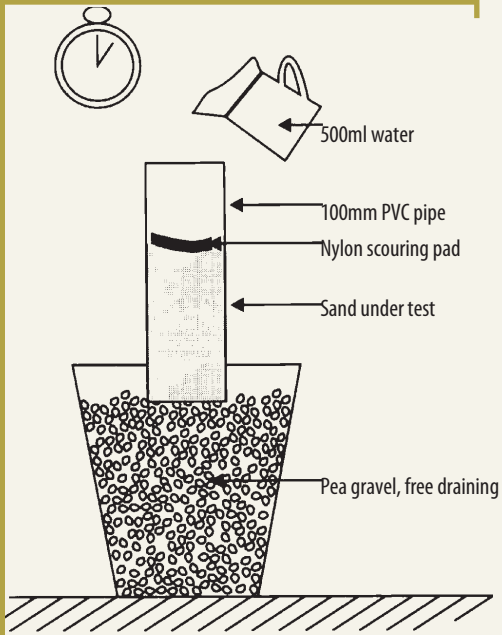

Sand suitability test (Cooper et al., 1996) FIGURE 18

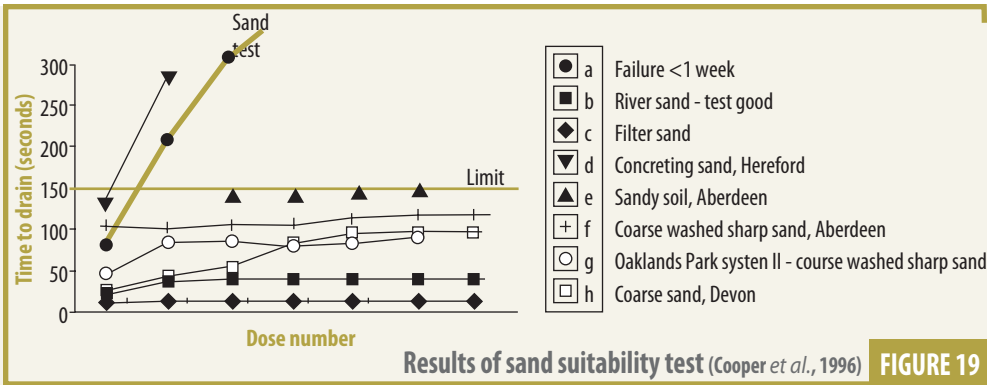

The graph shows results for some sands used by Grant and Moodie (1996) and gives an idea of the range of suitable sands. Sample a and d are clearly unsuitable. Sample e is close to limit and hence may be a risk. The sample c is clearly the best but samples b, g and h are satisfactory. Sands that drain in 50 – 150 seconds for 500 ml (once saturated) are satisfactory.

Plates 25 to 27 show the filling of substrates in a VF wetland.

6.4 Inlet and outlet structures

Inlet and outlet structures as mentioned in chapter 5.9 should be placed in accordance with the design. Inlet and outlet pipes of HF wetland should be laid perpendicular to the flow in the wetland. Figure 20 shows the layout of inlet and outlet arrangements for a HF constructed wetland. The distribution holes (orifices) in the network of inlet arrangement for VF wetlands should be so placed to assure equal distribution of wastewater through out the entire area of the wetland. Similarly, the network of outlet arrangement should be so placed to assure that no short-circuiting takes place inside the wetland. Plate 24, 25 and 29 show the construction of inlet and outlet structures.

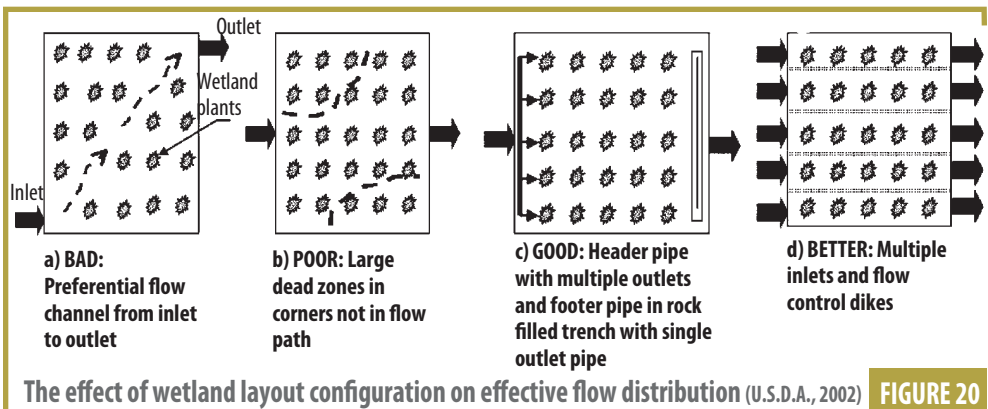

6.5 Planting vegetation

Establishing vegetation is probably the least familiar aspect of wetland construction. Vegetation can be introduced to a wetland by transplanting roots, rhizomes, tubers, seedlings, or mature plants; by broadcasting seeds obtained commercially or from other sites; by importing substrate and its seed bank from nearby wetlands; or by relying completely on the seed bank of the original site. Many of the wetlands are planted with clumps or sections of rhizomes dug from natural wetlands. Propagation from seed and planting of the established plantlets is gaining popularity.

Two main techniques for planting rhizomes are:

- Planting clumps
- Planting cuttings

Clumps of rhizome mat can be excavated from an existing stand of reeds whilst minimizing damage to the existing wetland and the rhizomes clump obtained. For the small scale wetland, it can be dug out with a spade but for large-scale projects the use of an excavator is required. When transporting or storing, clumps should not be stacked. In this way the aerial stems are not damaged. The spacing of planting depends on the size of the clumps obtained. Planting 1 m² clumps, at 10 m spacing or smaller clumps 1 or 2 m² should achieve full cover within one year depending upon mortality (Cooper *et. al.*, 1996).

Rhizome cuttings can be collected from the existing wetlands or from commercial nurseries. Sections of undamaged rhizome approximately 100 mm long with at least one internode, bearing either a lateral or terminal bud, should be used for planting. Rhizomes should be planted with one end about a half below the surface of the medium and other end exposed to the atmosphere at spacing of about 4 rhizomes per m².

Plates 24 and 29 show the newly planted wetland, whereas plates 30 and 31 show the wetland after vegetation growth.

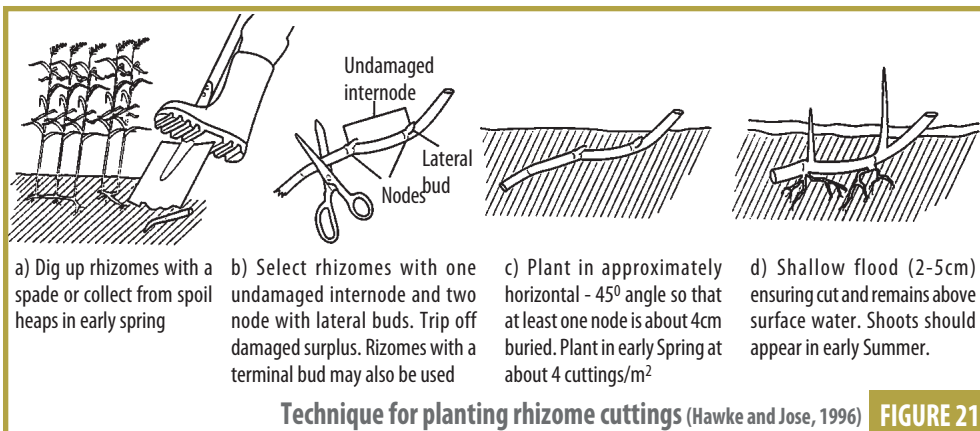

6.6 Water level management for the growth of vegetation

It is recommended to allow plantings to develop well before wastewater is introduced into the system; the plants need an opportunity to overcome planting stress before other stresses are introduced. Gradual increase in the concentration of waste applied may also be necessary. To have deep rooting water level should not be too high from the beginning.

Too much water creates more problems for wetland plants during the first growing season than too little water because the plants do not receive adequate oxygen at their roots. Wetland emergent species should be planted in a wet substrate (but not flooded) and allowed to grow enough to generate a stem with leaves. The photographs in the next pages illustrate the construction of constructed wetland at Sunga, Thimi Municipality, Nepal.

A view of the site for CW, which was being used as solid waste dumping site

PLATE 17



Site clearance, earthwork in excavation in progress

PLATE 18





Compaction of the subgrade works

PLATE 19



Construction of walls of the basin

PLATE 20



Basin ready for lining and filling of substrate

PLATE 21

Plastic liners placed
in the basin

PLATE 22



Filling substrate in
horizontal flow CW
(please note the inlet
and outlet zones)

PLATE 23



Horizontal flow CW
after completion
and plantation of
vegetation

PLATE 24





Installation of collection network and filling of substrate (drainage layer) in vertical flow CW

PLATE 25



Filling of substrate (main layer) in vertical flow CW

PLATE 26



Filling of substrate (protection layer) in vertical flow CW

PLATE 27

Filling of substrate completed in vertical flow CW

PLATE 28



Vertical flow CW after laying of inlet distribution network and plantation of vegetation

PLATE 29



Horizontal flow CW in operation after vegetation growth

PLATE 30





Vertical flow CW in operation and after vegetation growth

PLATE 31



A view of the constructed wetland after completion

PLATE 32

The construction of sludge drying beds is similar to the construction of vertical flow constructed wetlands except in the distribution arrangement of the sludge. Usually the sludge is fed into the sludge drying beds in one edge of the bed, which will slowly spread over the entire area of the sludge drying bed by gravity.

operation and maintenance

OPERATION and maintenance can be classified in terms of start-up, routine and long-term. There are important distinctions between these; start-up requirements will show more site-to-site variability, routine operations may be more affected by design details and long-term operations reflect loading. In addition, thorough check ups should be done at least twice a year for the effective operation of the wetland. Operation and maintenance of primary treatment is of high importance for the effective functioning of the wetland.

7.1 Start-up

Start-up periods for wetlands are necessary to establish the vegetation associated with the treatment processes. The start-up period will vary in length depending on the type of design, the characteristics of the influent wastewater, and the season of year. Although the start-up period for subsurface flow constructed wetlands is less critical since its performance is less dependent on vegetation, the vegetation adds up to the aesthetic values to the wetland.

During the start-up period, the operator is primarily responsible for adjusting the water level in the wetland. Typically, the wetlands will have to be filled with water to the surface of the substrate at the end of planting. As the plants begin to root, the water level can be gradually lowered to the design operating level.

7.2 Routine operation

Since constructed wetlands are “natural” systems, routine operation is mostly passive and requires little operator intervention. The operator must be observant, take appropriate actions when problems develop, and conduct required operational monitoring as necessary.

The most critical items in which operator intervention is necessary are:

- Adjustment of water levels
- Maintenance of flow uniformity (inlet and outlet structures)
- Management of vegetation
- Odor control
- Maintenance of berms (walls)

7.2.1 Adjustment of water levels

Water level and flow control are usually the only operational variables that have a significant impact on a well designed constructed wetland's performance. Changes in water levels affect the hydraulic residence time, atmospheric oxygen diffusion into the water phase, and plant cover. Significant changes in water levels should be investigated immediately, as they may be due to leaks, clogged outlets, breached berms, storm water drainage, or other causes.

7.2.2 Maintenance of flow uniformity

Maintaining uniform flow across the wetland through inlet and outlet adjustments is extremely important to achieve the expected treatment performance. The inlet and outlet manifolds should be inspected routinely and regularly adjusted and cleaned of debris that may clog the inlets and outlets. Debris removal and removal of bacterial slimes from weir and screen surfaces will be necessary. Submerged inlet and outlet manifolds should be flushed periodically. Additional cleaning with a high-pressure water spray or by mechanical means also may become necessary. Influent suspended solids will accumulate near the inlets to the wetland. These accumulations can decrease hydraulic detention times. Over time, accumulation of these solids will require removal.

7.2.3 Vegetation management

Wetland plant communities are self-maintaining and will grow, die, and regrow each year. The primary objective in vegetation management is to maintain the desired plant communities within the wetland. This is achieved through changes in the water levels and harvesting undesired plants (like weeds) when and where necessary. Where plant cover is deficient, management activities to improve cover may include water level adjustment, reduced loadings, pesticide application, and replanting. Harvesting and litter removal may be necessary depending on the design of the wetland. A well-designed and well-operated subsurface flow wetland should not require routine harvesting.

**A view of clogging
of perforations
due to sludge drift from
primary treatment**

Plate 33



**Sludge drift from
primary treatment
unit**

Plate 34



**Undesirable weeds
in the wetland**

Plate 35





Manual removal
of noxious and
undesirable weeds

PLATE 36



Harvesting wetland
vegetation

PLATE 37

7.2.4 Odor control

Odors are seldom a nuisance problem in properly loaded wetlands. Odorous compounds are typically associated with anaerobic conditions, which can be created by excessive BOD and ammonia loadings. Odor occurs if water is flooded in the surface of the bed therefore uniform distribution of water into the bed will prevent from odor. If primary treatment size if too big then wastewater may undergo anaerobic condition which may create odor when such wastewater feed into CW. However, such odor is insignificant since wastewater percolates into the bed quickly if there is no clogging.

7.2.5 Maintenance of berms (Walls)

Berms (walls) should be properly maintained. Any earthen berm erosion or crack in the walls should be repaired as soon as it is noted. Leaks around berms (walls) should also be repaired by plugging, sealing, etc. as soon as noted.

7.3 Long-term operations

Routine operations are essential in managing a wetland. In addition to regulatory requirements, inflow and outflow rates, wastewater quality, water levels should be regularly monitored and evaluated. Over time, these data help the operator to predict potential problems and select appropriate corrective actions.

Solids from preceding treatment units and litter from decaying vegetation will gradually reduce the pore space in the wetlands. Most of the solids will accumulate at the inlet end of the HF beds where the pore space may be reduced substantially in a couple of years. This may cause surface flow. The solids accumulation should be removed time to time. The rate of solids accumulation depends on loading.

The performance of the wetland should be assessed time to time. Samples should be collected and analyzed to ascertain the treatment efficiencies. Not the least but the following parameters need to be analyzed:

- Total Suspended Solids (TSS)
- Biochemical Oxygen Demand (BOD₅)
- Chemical Oxygen Demand (COD)
- Ammonia
- Nitrate
- Phosphorus
- Fecal Coliforms

The operation and maintenance requirements can be summarized as listed in Tables 5 to 7:

TABLE 5 Fortnightly O & M action list

Berm/Wall	<ul style="list-style-type: none">• Visual inspection for weeds, erosion and damage
Inlet	<ul style="list-style-type: none">• Visual inspection for adequate and uniform inflow and identification of blockages and damage• Maintain and adjust as required
Outlet	<ul style="list-style-type: none">• Visual inspection for blockages and damage, and visual check of water level and outflow quality and quantity
Vegetation	<ul style="list-style-type: none">• Visual inspection for any weed, plant health or pest problems. Take remedial action as necessary

TABLE 6 Two-monthly O & M action list

Berm/Wall	<ul style="list-style-type: none">• Visual inspection for weeds, erosion and damage. Take remedial action as necessary
Outlet	<ul style="list-style-type: none">• Check functioning of discharge system and apparent health of receiving water• Where appropriate, mow or graze (sheep only) grass on outer embankments and wetland surrounds
Vegetation	<ul style="list-style-type: none">• Control weeds in wetland by handweeding, herbicide application, and/or temporary water level increase
Primary treatment	<ul style="list-style-type: none">• Visual inspection of upstream primary treatment for structural integrity, quantity and quality of effluent

TABLE 7 Yearly O & M action list

Substrate	<ul style="list-style-type: none">• Check clogging of the substrate, remove the substrate, clean it and replace if necessary
Inlet	<ul style="list-style-type: none">• Remove end caps from inlet pipe and distribution network and flush out and clean thoroughly to remove slimes and blockages
Outlet	<ul style="list-style-type: none">• Clean and remove plants around outlet pipe to provide access and guard against blockages.
Vegetation	<ul style="list-style-type: none">• Harvest vegetation and replant if necessary
Primary treatment	<ul style="list-style-type: none">• Check sludge levels in primary treatment and desludge as necessary to maintain treatment performance and avoid sludge drift into wetland

constructed wetland for sludge drying

THE BASIS of using constructed wetlands for sludge drying is the long-term sludge volume reduction taking in wetlands, due to dewatering (draining, evapotranspiration) and mineralization of the organic solids in the sludge (Nielsen, 2003). Constructed wetlands for sludge drying is gaining popularity over conventional sludge drying beds due to the following advantages:

- Simple in operation and low operation and maintenance cost.
- Lower frequency of dewatered sludge removal from the bed, allowing for several years of sludge accumulation prior to bed emptying.
- Increased dewaterability due to evapotranspiration from vegetation and increased stability of sludge due to additional oxygen provided by rhizomes.
- The percolating liquid is subjected to microbial reactions within the wetlands, enabling nitrification and higher removal efficiencies within the liquid.

The basic design criteria for sludge drying beds are the Sludge Loading Rate (SLR), and the frequency of sludge application. The SLR values adopted by various researches and literatures ranges from 20 – 250 kg TS/m².year (Lienard *et al.*, 1995, Cooper *et al.*, 1996, Koottatep *et al.*, 2001, Nielsen, 2005). It is to be noted that the SLR are lower for low temperatures and higher for high temperatures. It is recommended to use a SLR of 200 kg TS/m².year in Nepal. The frequency for sludge application is generally once a week and the depth of sludge application should not be more than 30 cm.

The substrate profile used in sludge drying beds is similar to the vertical flow constructed wetland. Substrate depths ranging from 0.4 m to 0.8 m have been widely used (Cooper *et al.*, 1996, Shrestha, R.R., 1999, Nielsen, 2005). The recommended substrate profile (from bottom to top) for sludge drying beds is shown in Figure 22.

- 20 cm coarse gravel (20-40 mm grain size)
- 10 cm medium gravel (5-10 mm grain size)
- 10 cm fine sand (1-4 mm grain size)

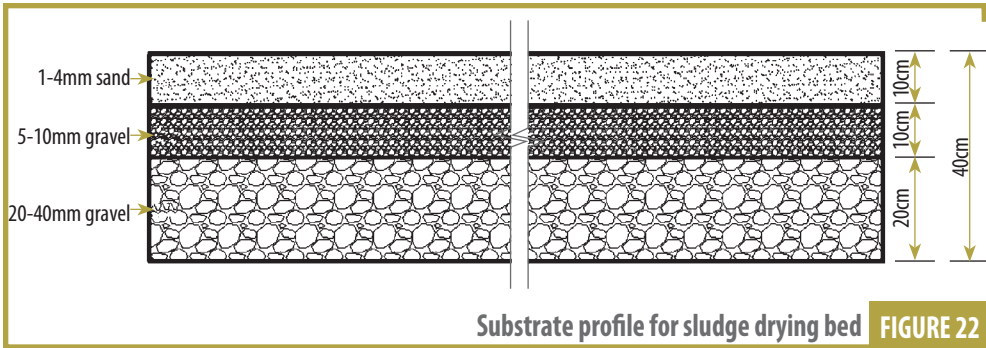

Substrate profile for sludge drying bed **FIGURE 22**

case studies

This section provides case studies of the following six constructed wetlands in Nepal.

- Hospital wastewater treatment (Dhulikhel Hospital)
- Combined laboratory and domestic wastewater treatment (ENPHO)
- Institutional wastewater treatment (Kathmandu University)
- Municipal wastewater treatment (Sunga, Thimi)
- Grey water treatment (Private residence)
- Septage and landfill leachate treatment (Pokhara)

The case study comprises a technical description of the wetlands used, performance, their operation and maintenance requirements and cost considerations.

9.1 Hospital wastewater treatment (Dhulikhel Hospital)

9.1.1 Technical description

The constructed wetland at Dhulikhel Hospital was constructed in the year 1997. The wastewater treatment plant comprises of a 3 chambered settling tank (16.5 m³) and a hybrid constructed wetland – Horizontal Flow (HF) followed by Vertical Flow (VF). The total area of the constructed wetland is 261 m² (HF – 140 m² and VF – 121 m²). The wetlands are earthen basin sealed with plastic liner.

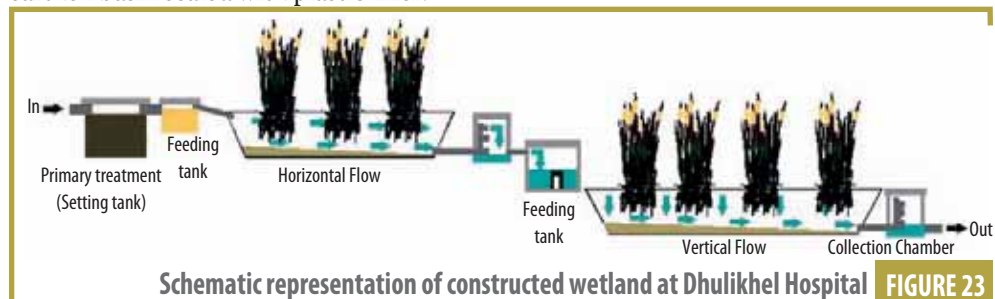

The HF wetland (0.65 – 0.7 m) was filled with 1 – 4 mm crushed gravel in the treatment zone, whereas 10 – 20 mm gravel was filled in the inlet/outlet zones. The inlet arrangement comprised of 100 mm diameter PVC pipe with 20 mm diameter holes at a distance of 2 m connected to a feeding tank (0.9 m³ per feed). The outlet arrangement comprised of 100 mm diameter perforated pipe with 6 mm diameter perforations.

The VF wetland (from top to bottom – 0.75 m sand, 0.10 m 5 – 8 mm gravel, 0.15 m 10 – 20 mm gravel and 0.05 m sand – total 1.05 m) was filled with sand as main layer. The d₁₀ and d₆₀/d₁₀ of sand was 0.40 mm and 1.5 respectively. The inlet arrangement comprised of 100 mm diameter pipe in the centre as main pipe with 6 branches of 50 mm diameter pipe connected to a feeding tank (1.5 m³ per feed). 8 mm and 6 mm holes were made in the branch pipes at a distance of 1 m. The outlet arrangement comprised of 3 numbers of 100 mm diameter perforated pipe with 6 mm diameter perforations.

TABLE 8 Technical description of Dhulikhel Hospital Constructed Wetland

Location	Dhulikhel, Kavre district
Year of operation	1997
CW Type	Sub surface flow
CW configuration	Horizontal Flow (HF) followed by Vertical Flow Bed (VF)
CW substrate	Sand, gravel
Type of wastewater	Hospital wastewater
Wastewater flow per day	10 m ³ in 1997 75 m ³ in 2006
Pre-treatment	Settlement tank – 16.5 m ³
Type of feeding	Intermittent
Population Equivalent (PE)	51 in 1997 386 in 2006
Total surface area of the CW	261 m ² (HFB – 140 m ² and VFB – 121 m ²)
Surface area per PE	5.1 m ² in 1997 0.7 m ² in 2006
Surface area per m³ volume of wastewater	26.1 m ² in 1997 3.5 m ² in 2006
Plant species	Phragmites Karka

The beds are planted with Phragmites karka and are operated with intermittent loading. The intermittent loading system is maintained hydro-mechanically. When the water level reaches certain height in the tank, a stopper stops the bucket to move up. Water level rises and fills the bucket. The bucket gets heavier and sinks down then the water flushes into the bed from the feeding tank (Refer Plate 7 and 8).

The wetland is being rehabilitated to treat about 90 m³/day of wastewater.



Constructed wetland at Dhulikhel Hospital in 1997 just after the construction (Shrestha R.R., 1999)

Plate 38

9.1.2 Performance

The performance of the wetland is shown in Figure 24. The removal efficiencies of BOD₅, COD and TSS are good till the increase of wastewater flow from 10 m³/day to 35 m³/day but have decreased when the wastewater flow is 75 m³/day, however, the effluent quality is still within the tolerance limits for the wastewater to be discharged into inland surface waters from combined wastewater treatment plant as given under Generic Standard – Part III by the Ministry of Population and Environment, Nepal.

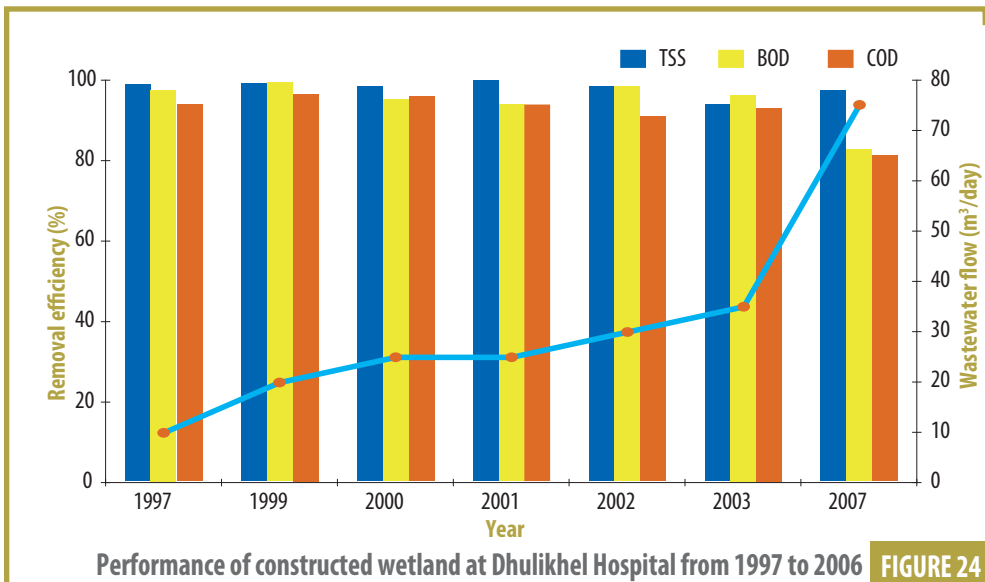

Performance of constructed wetland at Dhulikhel Hospital from 1997 to 2006 **FIGURE 24**

9.1.3 Operation and maintenance

A care taker is assigned to devote about 20% of the time for the operation and maintenance of the constructed wetland in addition to other duties of the hospital.

Regular maintenance works at the wetland comprised of removal of unwanted vegetation from the beds and cleaning of the inlet/outlet systems. The removal of unwanted vegetation is carried out about 2 – 3 times a year along with the general cleaning works. Vegetation is harvested once a year. The sludge from the settling tank is desludged at an interval of 3 – 6 months in the beginning whereas the sludge is being desludged in about 1 – 2 months at present time. This is due to the huge increase in wastewater flow to the wetland.

The substrate in the bed has been cleaned at surface once in the last ten years in case of vertical bed. The major problem encountered during the O & M of the wetland is the theft of parts of the wetland like manhole covers, pipes etc. since the wetland is relatively far from the hospital premises.

9.1.4 Costs

The total construction cost of the wetland amounted to NRs. 1,100,000 – US \$ 16,000 (i.e. NRs. 4,200 – US \$ 60 per m² of the wetland). The average O & M cost of the wetland is about NRs. 10,000 – US \$ 150 annually. About NRs. 30,000 – US \$ 430 has been spent for the replacement of pipes and manhole covers in the last 10 years.

9.2 Combined laboratory and domestic wastewater treatment and reuse (ENPHO)

9.2.1 Technical description

The constructed wetland at Environment and Public Health Organization (ENPHO) was constructed in the year 2002. The constructed wetland comprises of a settling tank (0.5 m³) and a vertical flow constructed wetland (15 m²).

The basin is constructed with brick masonry and the bed is sealed with plastic liner. The bed is filled with sand as main layer (from top to bottom – 0.60 m sand, 0.10 m 5 – 8 mm gravel and 0.10 m 10 – 20 mm gravel – total 0.80 m). The inlet arrangement comprised of 50 mm diameter pipe in the centre as main pipe with 2 branches of 50 mm diameter pipe connected to the settling tank with an intermittent feeding mechanism of 0.2 m³ per feed. 6 mm holes were made in the branch pipes at a distance of 1 m. The outlet arrangement comprised of 75 mm diameter perforated pipe with 6 mm diameter perforations.

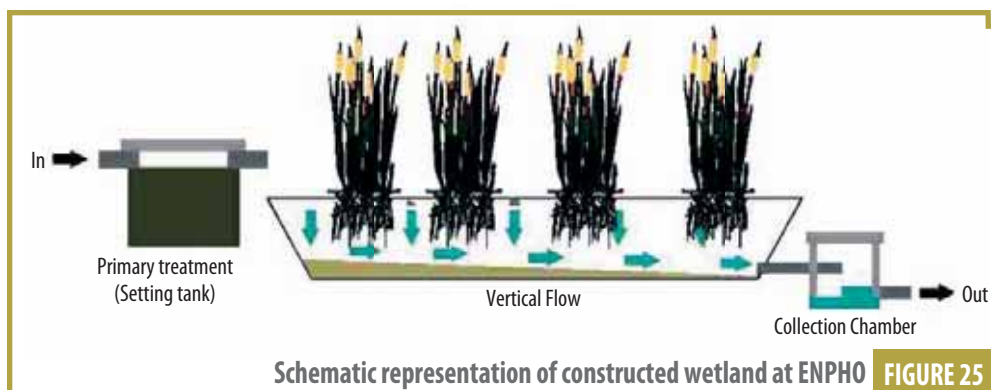

The beds are planted with *Phragmites karka* and are operated with intermittent loading system, which is maintained hydro-mechanically as described previously.

TABLE 9 Technical description of ENPHO constructed wetland

Location	Kathmandu Metropolitan City
Year of operation	2002
CW Type	Sub surface flow
CW configuration	Vertical Flow (VF)
CW substrate	Coarse Sand
Type of wastewater	Combined laboratory and domestic wastewater
Wastewater flow per day	0.7 m ³
Pre-treatment	Settlement tank – 0.5 m ³
Type of feeding	Intermittent
Population Equivalent (PE)	6.8
Total surface area of the CW	15 m ²
Surface area per PE	2.2 m ²
Plant species	Phragmites Karka

9.2.2 Performance

The performance of the wetland is shown in Figure 26. As seen from the figure, the removal efficiencies of the organic pollutants are good.

9.2.3 Operation and maintenance

Regular maintenance works at the wetland comprised of removal of unwanted vegetation from the beds and cleaning of the inlet system. The removal of unwanted vegetation is

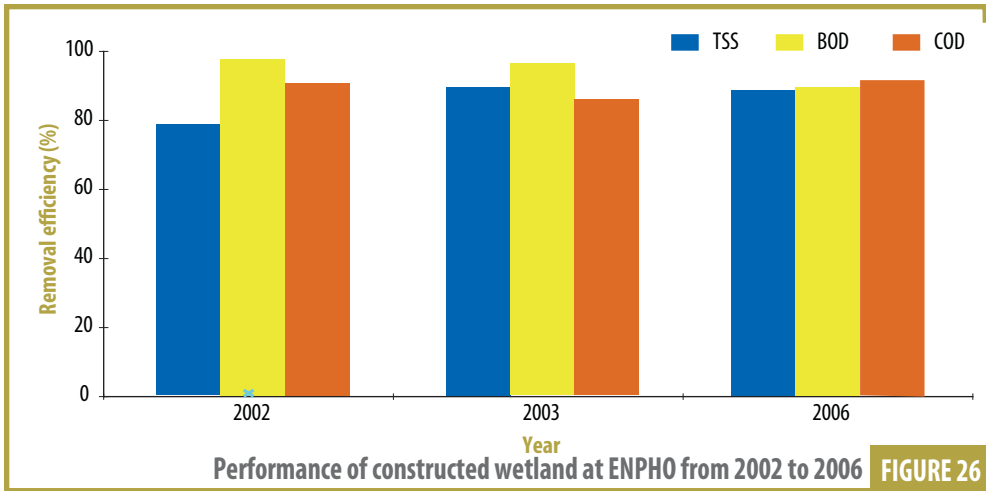

Constructed wetland at ENPHO
PLATE 39

carried out monthly along with the general cleaning works. Vegetation is harvested twice a year. The sludge from the settling tank is desludged at an interval of 6 months but sometimes sludge is desludged a little earlier.

Due to clogging on the surface of the bed, the top layer of the bed was removed and filled with coarse sand in 2005.

9.2.4 Costs

The total construction cost of the wetland amounted to NRs. 40,000 – US \$ 570 (i.e. NRs. 2,700 – US \$ 40 per m² of the wetland). The operation and maintenance costs are reported to be negligible. In addition, the reuse of treated wastewater resulted in saving of water expenses of ENPHO.

The treated wastewater at ENPHO is recycled for non potable purposes like flushing, cleaning vehicles, gardening etc. Apart from the recycling of wastewater, ENPHO has installed rainwater harvesting in its building, which is about 170 m² roof catchment. Rainwater is collected in an underground tank with a capacity of 10 m³. Excess rainwater, especially in the monsoon, is diverted to the dugwell for groundwater recharge. **Recycling of wastewater and rainwater harvesting saves around NRs. 4,000 (US \$ 60) per month otherwise spent in buying water.**

9.3 Institutional wastewater treatment (Kathmandu University)

9.3.1 Technical description

The constructed wetland at Kathmandu University was constructed in the year 2001. The wastewater treatment plant comprises of a settling tank (40 m³) and a hybrid constructed wetland – Horizontal Flow (HF) bed followed by two Vertical Flow (VF) beds. The total area of the constructed wetland is 628 m² (HF – 290 m² and VF – 338 m²).

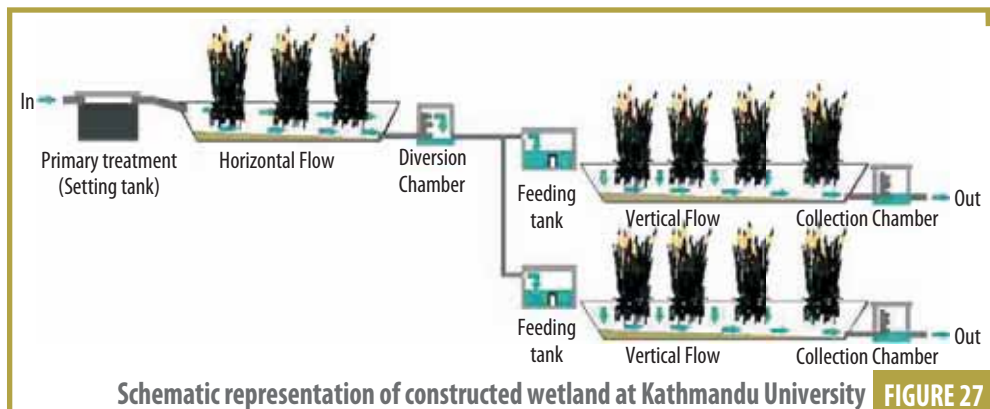

The walls of the wetlands are constructed in brick masonry sealed with plastic liner on top of clay lining (100 mm thick compacted black cotton soil).

TABLE 10 Technical description of Kathmandu University constructed wetland

Location	Dhulikhel
Date of operation	2001
CW Type	Sub surface flow
CW configuration	Horizontal Flow (HF) followed by Vertical Flow (VF)
CW substrate	Sand, gravel
Type of wastewater	Institutional wastewater
Wastewater flow per day	30 m ³
Pre-treatment	Settlement tank – 40 m ³
Type of feeding	Intermittent
Population Equivalent (PE)	193
Total surface area of the CW	628 m ² (HFB – 290 m ² and VFB – 338 m ²)
Surface area per PE	3.3 m ² (The area of the bed was estimated at the time of operation. The area will be reduced with the increase of wastewater flow as this wetland was designed for more than 50m ³ /day of wastewater.)
Plant species	Phragmites Karka

The HF wetland (0.6 – 0.7 m) was filled with 5 mm round gravel in the treatment zone, whereas > 5 mm gravel was filled in the inlet/outlet zones. The inlet arrangement comprised of 100 mm diameter PVC pipe with 20 mm diameter perforations at a distance of 0.6 m centre to centre. The inlet pipe is placed 20 to 30 cm higher than the substrate and rested on concrete blocks. The outlet arrangement comprised of 100 mm diameter perforated pipe.

The VFB was filled with sand as main layer of porosity 37%. The d_{10} and d_{60}/d_{10} of sand was 0.40 mm and 1.5 respectively. The inlet arrangement comprised of 110 mm diameter pipe in the centre as main pipe with 6 branches of 50 mm diameter pipe connected to a feeding tank (2.5 m³ per feed).

The beds are planted with *Phragmites karka*. HFB is loaded continuously whereas the VFBs are operated with intermittent loading system, which is maintained hydro-mechanically as described previously.

9.3.2 Performance

The performance of the wetland is shown in Figure 28.



Constructed wetland at Kathmandu University (Shrestha R.R.)

PLATE 40

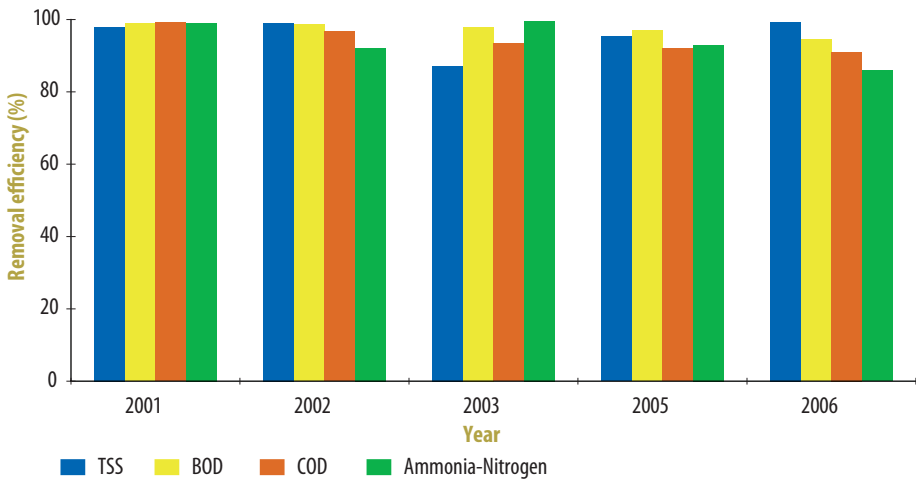

Performance of constructed wetland at Kathmandu University from 2001 to 2006 **FIGURE 28**

9.3.3 Operation and maintenance

Regular maintenance works at the wetland comprised of removal of unwanted vegetation from the beds and harvesting of the vegetation. The removal of unwanted vegetation is carried out four times a year while the harvesting of vegetation is carried out twice a year. The sludge from the settling tank is desludged once in the year 2006.

The substrate in the bed has not been changed yet, but the substrate is partially clogged and needs to be washed. The major problem encountered during the O & M of the wetland is the leakage from the tanks and inlet/outlet arrangement systems. The other problem encountered during the O & M of the wetland is the theft of parts of the wetland like manhole covers, pipes etc. The problems in the maintenance of the intermittent feeding system through hydro mechanical siphon has also been reported.

9.3.4 Costs

The total construction cost of the wetland amounted to NRs. 1,800,000 – US \$ 26,000 (i.e. NRs. 2,900 – US \$ 40 per m² of the wetland). The average O & M cost of the wetland is about NRs. 20,000 – US \$ 290 annually.

9.4 Municipal wastewater treatment (Sunga)

9.4.1 Technical description

The constructed wetland at Sunga, Thimi Municipality was constructed in the year 2005. The wastewater treatment plant comprises of a coarse screen and a grit chamber as preliminary treatment, an anaerobic baffle reactor (42 m³) as primary treatment, hybrid constructed wetland – Horizontal Flow (HF) followed by Vertical Flow (VF) as secondary treatment and Sludge Drying Bed (SDB) as sludge treatment. The total area of the constructed wetland is 375 m² (HF – 150 m², VF – 150 m² and SDB – 70 m²).

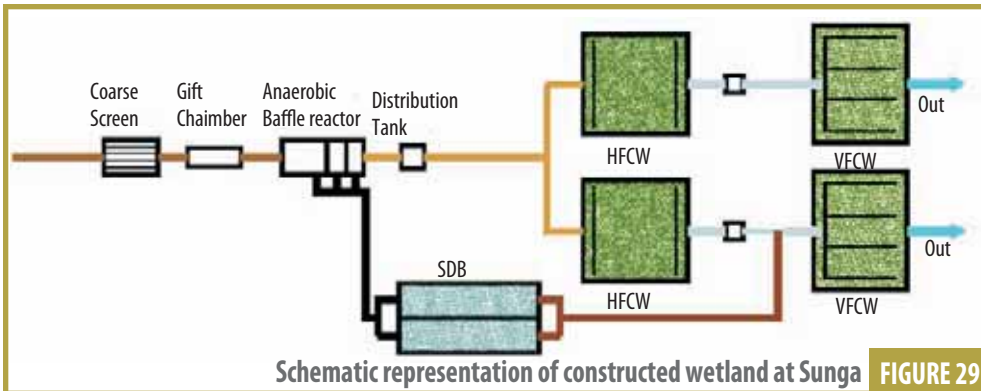

FIGURE 29

The walls of the beds are constructed in brick masonry sealed with plastic liner laid above compacted earth.

TABLE 11 Technical description of Sunga Constructed Wetland

Location	Sunga, Thimi Municipality
Date of operation	October 2005
CW Type	Sub surface flow
CW configuration	Horizontal Flow (HF) followed by Vertical Flow (VF)
CW substrate	Sand, gravel
Type of wastewater	Municipal wastewater
Wastewater flow per day	10 m ³
Pre-treatment	Anaerobic Baffle Reactor – 42 m ³
Type of feeding	Continuous in HFB Intermittent in VFB
Population Equivalent (PE)	285.7
Total surface area of the CW	300 m ² (HFB – 150 m ² and VFB – 150 m ²)
Surface area per PE	1.05
Plant species	Phragmites Karka

The HF bed (0.4 – 0.5 m) was filled with 10 – 20 mm gravel in the treatment zone, whereas 20 – 40 mm gravel was filled in the inlet/outlet zones. The inlet arrangement comprised of 150 mm diameter PVC pipe with 20 mm diameter perforations at a distance of 0.3 m centre to centre in one HF and in the other 150 mm PVC pipe with 0.3 m slots. The inlet pipe is placed just above the substrate. The outlet arrangement comprised of 150 mm diameter perforated pipe with 6 mm perforations.

The VF bed (from top to bottom – 0.05 m 5 – 10 mm gravel, 0.30 m coarse sand, 0.05 m 5 – 10 mm gravel and 0.15 m 10 – 20 mm gravel as drainage layer – total 0.55 m) was filled with coarse sand as main layer. The d_{10} and d_{60}/d_{10} of sand was 0.35 mm and 3.3 respectively. The inlet arrangement comprised of a network of 100 mm diameter pipe connected to a feeding tank (1.5 m³ per feed). 6 mm holes were made in the pipes at a distance of 1 m. The outlet arrangement comprised of a 100 mm diameter perforated pipe with 6 mm diameter perforations in the centre with 4 lateral connections of same 100 mm diameter perforated pipes.

The SDB is filled with substrate arranged as below (from top to bottom):

- 30 cm coarse sand
- 5 cm medium gravel (5 – 10 mm grain size)
- 15 cm coarse gravel (20 – 40 mm grain size)

One HF bed is planted with *Phragmites karka* and the other with *Canna latifolia*. VF beds are planted with *Phragmites karka*. HFBs are loaded continuously whereas the VFBs are

operated with intermittent loading system, which is maintained hydro-mechanically as described previously.



Constructed wetland at Sunga
PLATE 37

9.4.2 Performance

The overall performance of the wetland is shown in Figure 30. Treatment efficiency of this wetland is highly dependent on the timely desludging of the ABR. Table 12 shows the concentration of pollutants in August 2006.

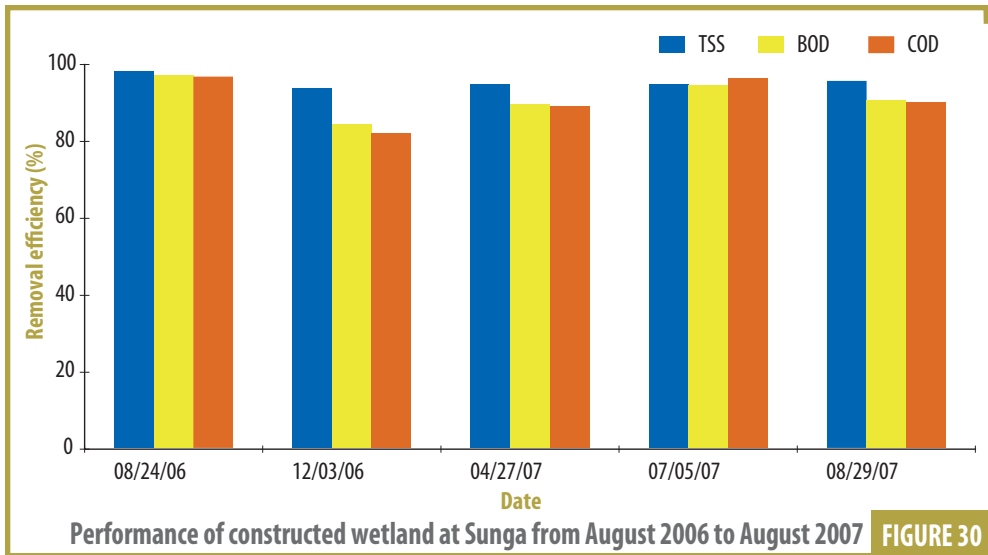

Performance of constructed wetland at Sunga from August 2006 to August 2007 FIGURE 30

TABLE 12 Concentrations of pollutants at Sunga (August 2006)

PARAMETERS	UNITS	RAW	ABR	HFCW	VFCW
TSS	mg/l	7 96	204	28	16
BOD ₅	mg/l	950	450	165	30
COD	mg/l	1,438	1,188	213	50
Ammonia	mg/l	145.5	408.9	214.1	21.0
Nitrate	mg/l	4.1	36.8	32.6	566.2
Total Phosphorus	mg/l	26.4	44.3	20.4	24.3
Fecal Coliform	CFU/1ml	1.3E+5	1.3E+6	1.1E+6	8.1E+3

9.4.3 Operation and maintenance

A care taker is assigned for the operation and maintenance of the constructed wetland. Regular maintenance works at the wetland comprised of weekly removal of unwanted vegetation from the beds and monthly cleaning of the inlet/outlet systems. The harvesting of the vegetation is carried out twice a year. The sludge from the anaerobic baffle reactor has been desludged once.

9.4.4 Costs

The total construction cost of the wetland amounted to NRs. 2,200,000 – US \$ 31,500 (i.e. NRs. 5,850 – US \$ 85 per m² of the wetland). The operation and maintenance cost of the wetland is about NRs. 36,000 – US \$ 520 per annum.

9.5 Grey water treatment (Private residence)

9.5.1 Technical description

The constructed wetland at a private residence was constructed in the year 1998. The constructed wetland comprises of a settling tank (0.5 m³) and a vertical flow constructed wetland (6 m²).

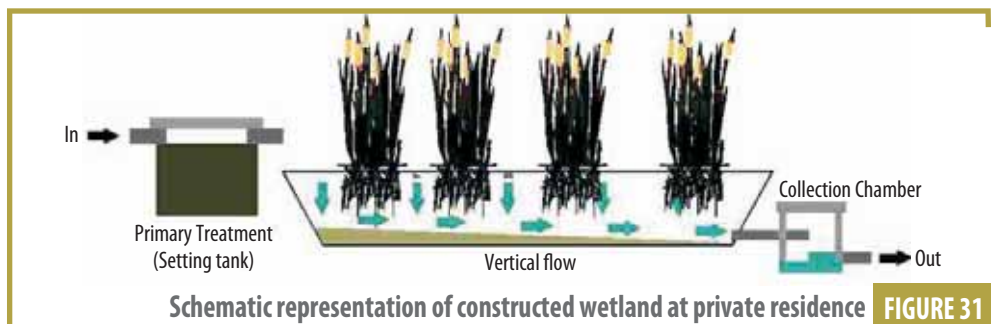

TABLE 13 Technical description of Constructed Wetland at Private Residence

Location	Ward No. 15, KMC
Date of operation	April 1998
CW Type	Sub surface flow
CW configuration	Vertical Flow (VF)
CW substrate	Sand, gravel
Type of wastewater	Grey water
Design flow per day	0.5 m ³
Pre-treatment	Settlement tank – 0.5 m ³
Type of feeding	Intermittent
Population Equivalent (PE)	8
Total surface area of the CW	6 m ²
Surface area per PE	0.7 m ²
Plant species	Phragmites Karka and Canna latifolia

The basin is constructed with brick masonry and the bed is sealed with plastic liner. The bed is filled with 0.8 m coarse sand as main layer above 0.2 m 20 – 40 mm gravel as drainage layer. The inlet arrangement comprised of 25 mm diameter pipe in the centre connected to the settling tank with an intermittent feeding mechanism of 0.2 m³ per feed. 6 mm holes were made in the pipe at a distance of 1 m. The outlet arrangement comprised of 75 mm diameter perforated pipe with 6 mm diameter perforations in the centre leading to a collection tank.

The bed is planted with *Phragmites karka* and *Canna latifolia* and is operated with intermittent loading system, which is maintained hydro-mechanically as described previously.



Vertical flow constructed wetland in construction (Shrestha R.R., 1999)

PLATE 37



Vertical flow constructed wetland in use (Shrestha R.R., 1999)

PLATE 37

9.5.2 Performance

The performance of the wetland is shown in Figure 32.

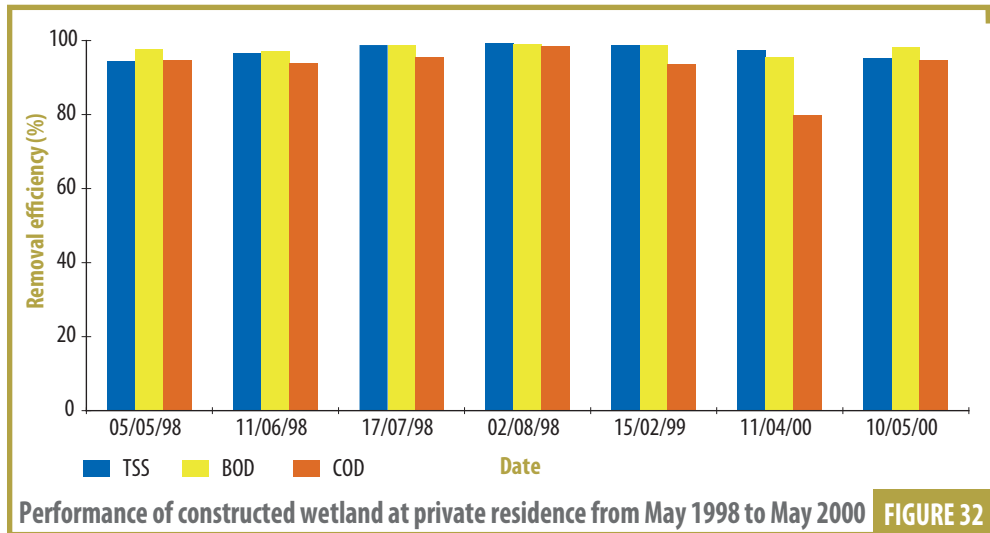

9.5.3 Operation and maintenance

The following operation and maintenance was performed to ensure proper functioning of the wetland:

- Regular inspection of feeding tank (combined with settling tank) to ensure proper operation of the siphon and intermittent feeding to the vertical flow bed.
- Regular removal of unwanted vegetation in the bed.
- Annual harvesting of the vegetation.
- Annual desludging of the settling tank.

9.5.4 Costs

The total construction cost of the wetland amounted to NRs. 36,000 – US \$ 520 (i.e. NRs. 6,000 – US \$ 85 per m² of the wetland). The operation and maintenance costs are reported to be negligible. In addition, the reuse of grey water resulted in saving of water expenses of the residence.

9.6 Septage and landfill leachate treatment (Pokhara)

9.6.1 Technical description

The septage and landfill leachate treatment plant at Pokhara under the Pokhara Environmental Improvement Project was constructed in the year 2003. The treatment plant was designed to treat 35 m³/day of septage and 40 m³/day of landfill leachate. The treatment plant comprises of the following units:

- 7 compartmental sludge drying beds – SDB (1,645 m²);
- 2 compartmental horizontal flow constructed wetland – HF (1,180 m²); and
- 4 compartmental vertical flow constructed wetland – VF (1,500 m²).

The 1.5 to 1.9 m deep SDB is filled with substrate arranged as below (from bottom to top):

- 20 cm coarse gravel (20 – 40 mm grain size)
- 10 cm medium gravel (5 – 10 mm grain size)
- 10 cm fine sand (0.1 – 1 mm grain size)

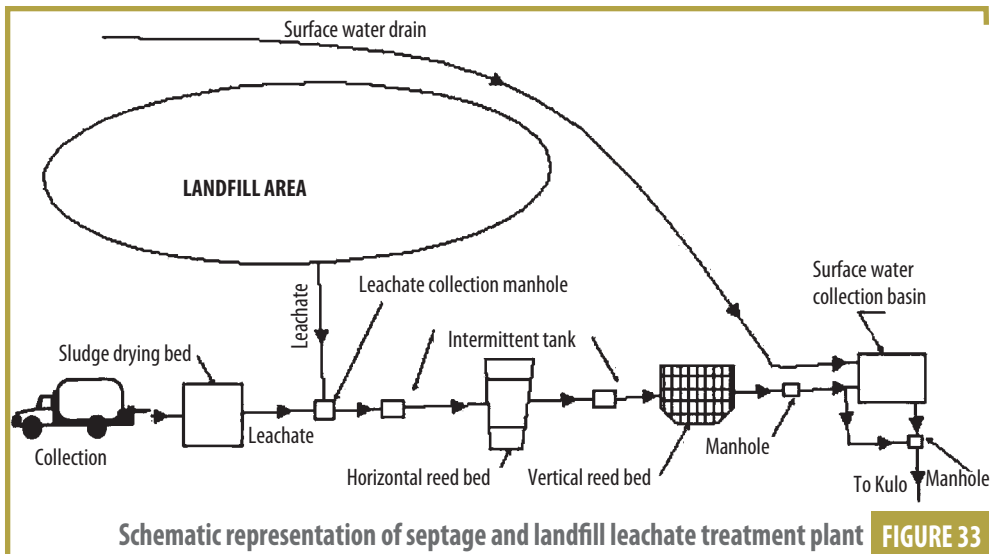

The HF wetland (0.5 – 0.7 m) was filled with coarse sand (3 – 6 mm grain size) in the treatment zone, whereas 10 – 20 mm gravel was filled in the inlet/outlet zones. The inlet arrangement comprised of 100 mm diameter PVC pipe with 20 mm diameter holes at a distance of 2 m connected to a feeding tank (0.9 m³ per feed). The outlet arrangement comprised of 100 mm diameter perforated pipe with 6 mm diameter perforations.

The 0.9 m deep VF wetland is filled with substrate arranged as below (from bottom to top):

- 20 cm coarse gravel (20 – 40 mm grain size) – drainage layer including the drainage pipes
- 10 cm medium gravel (5 – 10 mm grain size) – transition layer
- 60 cm medium sand (1 – 4 mm grain size) – main layer

The inlet arrangement comprised of 100 mm diameter pipe in the centre as main pipe with several branches of 50 mm diameter pipe connected to a feeding tank (11.25 m³ per feed). The beds are planted with *Phragmites karka* and are operated with intermittent loading.

9.6.2 Costs

The total construction cost of the wetland amounted to NRs. 6,000,000 – US \$ 85,700 (i.e. NRs. 1,400 – US \$ 20 per m² of the wetland).



Sludge drying bed
(Shrestha R.R.)

PLATE 44



**Horizontal flow
constructed wetland**
(Shrestha R.R.)

PLATE 45



**Vertical flow
constructed wetland**
(Shrestha R.R.)

PLATE 46



references

Brix, H. (1997). Do Macrophytes play a Role in Constructed Wetlands? *Water Science and Technology*, Vol: 35(5), pg. 11-17.

Brix, H. (2004). Danish guidelines for small-scale constructed wetland systems for onsite treatment of domestic sewage. In Proc. 9th International conference on wetland systems for water pollution control, Avignon, France.

Cooper P.F., Job G.D., Green M.B. and Shutes R.B.E. (1996). Reed Beds and Constructed Wetland for Wastewater Treatment. WRc Swindon, UK.

Cooper, P.F. (1990). European Design and Operation Guidelines for Reed Bed Treatment Systems, Report No UI 17, Water Research Center, Swindon , UK.

Crites, R. and Tchobanoglous, G. (1998). *Small and decentralized wastewater management systems*. Water Resources and Environmental Engineering, 1. WCB/McGraw-Hill, Boston.

Foxon, K.M., Pillay, S., Lalbahadur, T., Rodda, N., Holder, F. and Buckley, C.A. (2004). The anaerobic baffled reactor (ABR): An appropriate technology for on-site sanitation. In Proceedings: 2004 Water Institute of South Africa (WISA) Biennial Conference, Cape Town, South Africa.

Garcia J., Morator J., Bayona J.M. and Aguirre P. (2004). Performance of horizontal surface flow constructed wetlands with different depths. Proceedings – 9th International Conference on Wetland Systems for Water Pollution Control, 26 – 30 September 2004, Avignon, France, pp. 269 – 276.

Gearheart, R.A. (1992). Use of constructed wetlands to treat domestic wastewater, City of Arcata, California. *Water Science Technology* 26, 1625-1637.

Gesellschaft zur Förderung der Abwassertechnik d.V. (GFA) (1998). Arbeitsblatt ATV – A 262 Grundsätze für Bemessung, Bau und Betrieb von Pflanzenbeetwn für kommunales Abwasser bei Ausbaugrößen bis 1000 Einwohnerwerte, St. Augustin, Germany.

Haberl R. (1999). Constructed Wetlands: A Chance to Solve Wastewater Problems in Developing Countries. *Water Science and Technology*, Vol: 40(3).

Hawke, C. J. and Jose, P. V. (1996). Reed Bed Management for Commercial and Wildlife Interests. Royal Society for Protection of Birds. Ref: 24/571/95, UK.

IWA Specialist Group on Use of Macrophytes in Water Pollution Control (2000). Constructed Wetlands for Pollution Control - Processes, Performance, Design and Operation, Scientific and Technical Report No:8. Kadlec R.H., Knight R.L., Vzmayal J., Brix H., Cooper P. and Haberl R. (eds), International Water Association, London.

Kickuth, R. (1984). The Root Zone Method. Gesamthochschule Kassel-Uni des Landes, Hessen.

Koottatep, T., Polprasert, C., Oanh, N.T.K, Heinss, U., Montangero A. and Strauss M. (2001). *Septage dewatering in vertical-flow constructed wetlands located in the tropics*, *Wat. Sci. Tech.*, Vol. 44 No. 2-3 pp181-188.

Korkusuz E. A., (2005). Manual of practice on constructed wetlands for wastewater treatment and reuse in Mediterranean countries. Added Value Knowledge Report (AVKR 5) – Mediterranean Network on Wastewater Reclamation and Reuse (MED-REUNET) II.

Lienard, A., Boutin C. and Esser, D. (1990). Domestic Wastewater Treatment with Emergent Helophyte Beds in France. In: Cooper and B. C. Findlater (Eds). *Constructed Wetlands in Water Pollution Control*. Pergamon Press, Oxford U.K. pp 183 - 192.

Lienard, A., Duchene. Ph. and Gorini, D. (1995). *A study of activated sludge dewatering in experimental reed planted or unplanted sludge drying beds*. *Wat. Sci. Tech.*, 32(3), 251-261

Loudon, T., Bounds, T., Converse, J., Konsler, T. and Rock, J. (2005). *Septic Tanks*. Model Decentralized Wastewater Practitioner Curriculum, National Decentralized Water Resources Capacity Development Project. CIDWT, Raleigh, NC.

Mara, D. (1996). *Low-Cost Urban Sanitation*, John Wiley & Sons, Chichester, West Sussex, England.

Metcalf & Eddy, Inc. (2003). *Wastewater Engineering – Treatment and Reuse*, Tata McGraw-Hill Publishing Company Limited, New Delhi, India.

Molle P., Liénard A., Boutin C., Merlin G. and Iwema A. (2004). How to treat raw sewage with constructed wetlands: An overview of the French systems. In *Proceedings – 9th International Conference on Wetland Systems for Water Pollution Control*, Avignon, France.

Morel A. and Diener S. (2006). *Greywater Management in Low and Middle-Income Countries, Review of different treatment systems for households or neighbourhoods*. Swiss Federal Institute of Aquatic Science and Technology (Eawag). Dübendorf, Switzerland.

Nielson, S. (2003). *Sludge drying reed beds.* Wat. Sci. Tech., Vol 48 No. 5 pp 101-109.

Nielson, S. (2005). *Sludge reed bed facilities: operation and problems.* Wat. Sci. Tech., Vol 51 No. 9 pp 99-107

ÖNORM B 2505 (1997). Bepflanzte Bodenfilter (Pflanzenkläranlagen) – Anwendung, Bemessung, Bau und Betrieb (Subsurface flow constructed wetlands – Application, Dimensioning, Installation and Operation), Österreichisches Normungsinstitut: Vienna, Austria.

Philippi L.S., Sezerino P.H., Bento A.P. and Magri M.E. (2004). Vertical flow constructed wetlands for nitrification of anaerobic pond effluent in southern Brazil under different loading rates. Proceedings – 9th International Conference on Wetland Systems for Water Pollution Control, 631 – 639.

Platzer C. (1998). Design recommendation for subsurface flow constructed wetlands for nitrification and denitrification. In: Proceedings of the 6th International Conference on Wetland Systems for Water Pollution Control, Sao Paulo State, Brazil.

Platzer C. (2000). Development of Reed Bed systems-A European Perspective”. In: Proceedings of the IWA 7th International Conference on Wetland Systems for Water Pollution Control, Lake Buena Vista, Florida.

Reed S.C. et al. (1990). Natural systems for wastewater treatment – Manual of practice FD16. Water Pollution Control Federation, 601 Wyhe Street Alexandria, Virginia. Cited by Grant, N. and Griggs J. (2001). Reed beds for the treatment of domestic wastewater, BRE.

Reed S.C., Crites R. and Middlebrooks E.J. (1995). Natural Systems for Waste Management and Treatment. 2nd Edition, McGraw-Hill, New York, United States.

Reed, S.C.; Middlebrooks, E.J. and Crites, R.W. (1988). Natural Systems for Waste Management. McGraw-Hill Book Company, New York.

Ritzema, H.P. (Editor-in-Chief) (1994). *Drainage principles and applications.* International Institute for Land Reclamation and Improvement, Wageningen, The Netherlands.

Sasse, L. (1998). *Decentralised wastewater treatment in developing countries.* BORDA, Bremen.

Shrestha, R. R. (1999). Application of Constructed Wetlands for Wastewater Treatment in Nepal. Ph. D. Dissertation, Department of Sanitary Engineering and Water Pollution Control. University of Agricultural Sciences Vienna, Austria.

Steiner G.R. and Watson J.T. (1993). General design, construction and operation guidelines: Constructed wetlands wastewater treatment systems for small users including individual residences; 2nd Edition, TVA/WM-93/10, Tennessee Valley Authority Resource Group Water Management: Chattanooga, TN, United States.

United States Department of Agriculture (U.S.D.A.), (2002). *Part 637 Environmental Engineering National Engineering Handbook – Chapter 3 Constructed Wetlands.* 210-VI-NEH, U.S.D.A., Natural Resources Conservation Service, Washington DC, United States.

United States Environmental Protection Agency (U.S. EPA) (1988). Design manual: Constructed wetlands and aquatic plant systems for municipal wastewater treatment, EPA 625/1-88/022, U.S. EPA Office of Water: Cincinnati, OH, United States.

United States Environmental Protection Agency (U.S. EPA) (1993). Guidance for design and construction of subsurface flow constructed wetland, U.S. EPA Region 6 Water Management Division Municipal Facilities Branch Technical Section.

United States Environmental Protection Agency (U.S. EPA) (2000). Constructed wetlands treatment of municipal wastewater treatment. EPA 625/R-99/010, U.S. EPA Office of Research and Development: Washington, D.C., United States.

Vymazal J. (1997). The use of subsurface flow constructed wetlands for wastewater treatment in the Czech Republic. *Ecological Engineering* 7 1-14.

Vymazal, J., Brix, H., Cooper, P.F., Green, M.B. and Haberl, R. (Eds.) (1998). *Constructed Wetlands for Wastewater Treatment in Europe.* Backhuys Publishers, Leiden.

Walker, A. (2006). Predicting the clogging of saturated substrates used in the construction of vertical flow systems by suspended solids. M.Sc. Thesis, Cranfield University, Silsoe, UK.

Wallace, S.D. and Knight, R.L. (2006). Small scale constructed wetland treatment systems – feasibility, design criteria and O&M requirements. Report 01-CTS-5, Water Environment Research Foundation (WERF), Alexandria.

Wanasen, S.A. (2003). *Upgrading conventional septic tanks by integrating in-tank baffles.* M.Sc. Thesis, School of Environment, Resources and Development, Asian Institute of Technology, Bangkok, Thailand.

Watson, J.T., Reed, S.C., Kadlec, R.H., Knight, R.L. and Whitehouse, A.E. (1989). Performance Expectations and Loading Rates for Constructed Wetlands. In: Hammer, D. A. (Ed.), *Constructed Wetlands for Wastewater Treatment*, Michigan.

Wetlands International (2003). The use of constructed wetlands for wastewater treatment. Wetlands International – Malaysia Office, Selangor, Malaysia.

WHO/UNICEF Joint Monitoring Programme for Water Supply and Sanitation (2004). Meeting the MDG drinking water and sanitation target: a mid-term assessment of progress. <http://www.who.int/water_sanitation_health/monitoring/jm04.pdf>

How to treat raw sewage with constructed wetlands: An overview of the French systems

P. Molle*, A. Lienard*, C. Boutin*, G. Merlin**, A. Iwema***

* Cemagref, Research unit: Water quality and pollution prevention, 3bis, quai Chauveau - CP 220, 69336 Lyon Cedex 09 - France (E-mail: pascal.molle@cemagref.fr; a;ain.lienard@cemagref.fr)

** Laboratoire OCIE, Equipe Biotechnologies et Genie des Procédés pour l'Environnement -ES1GEC Université de Savoie 73376 Le Bourget du Lac France (E-mail: gerard.merlin@univsavoie.fr)

*** Agence de l'Eau Rhone Mediterranee Corse, 2-4 allée de Lodz, 69363 Lyon Cedex 07 -France (E-mail: Arthur.IWEMA@eaurnc.fr)

Abstract

The development of Vertical Flow Constructed Wetlands treating raw wastewater in France has proved to be very successful over the last 20 years. In view of this a survey was carried out on more than 80 plants in order to study their performance and correct design if necessary. This study shows that such systems perform well in terms of respecting the goals of both low level outlet COD and SS and nitrification. Pollutant removal performance in relation to the loads handled and the specific characteristics of the plants were investigated. Nitrification is shown to be the most sensitive process in such systems and performance in relation to sizing is discussed. Such systems, if well designed, can achieve an outlet level of 60 mg.L⁻¹ in COD, 15 mg.L⁻¹ in SS and 8 mg.L⁻¹ in TKN with an area of 2 to 2.5m².PE⁻¹. The sludge deposit on the first stage must be removed after about 10-15 years.

Keywords

Vertical flow constructed wetlands; raw sewage; data collection; design; performance.

Introduction

Among the different constructed wetlands systems treating domestic wastewater the two stage Vertical Flow Constructed Wetland (VFCW) is the most common design found in France. The particularity of this system is that it accepts raw sewage directly onto the first stage allowing for easier sludge management in comparison to dealing with primary sludge from an Imhoff settling/digesting tank. The use of this system, developed by Cemagref more than 20 years ago (Lienard *et al.*, 1987), really took off when applied by the SINT company during the 1990's. With the passing of time this system has gained a good reputation for small community wastewater treatment. Now it is well developed and several companies offer this process. The sizing of such a system is rather empirical, based on the knowledge gained by Cemagref over years of laboratory studies and full-scale experiments on attached growth culture. General guidelines were proposed (Boutin *et al.*, 1997; Lienard *et al.*, 1998) to avoid bad conceptual design which could have damaged development of the system. The sizing of the reed bed filters is based on an acceptable organic load expressed as a filter surface unity per Person Equivalent (PE). Current recommendations are 2 stages of filters, the first of which is divided into 3 filters and the second into 2 filters. Filter configuration and media profile can be seen in figures 1 and 2.

Each primary stage unit receives the full organic load during the feeding phase, which often lasts 3 to 4 days, before being rested for twice this amount of time. These alternating phases of feed and rest are fundamental in controlling the growth of the attached biomass on the filter media, to maintain aerobic conditions within the filter bed and to mineralise the organic deposits resulting from the SS, contained in the raw sewage which are retained on the surface of the primary stage filters (Lienard *et al.*, 1990b). Then effluent is sent to the second stage to complete treatment and, in particular, nitrification. The surface recommended per stage, which could be adapted according to the climate, the level of pollutant removal required by water authorities and the hydraulic load (HL) due to for example, the amount of clean water intrusion into the sewerage network (even though VFCWs have mostly been recommended for separate networks until now), can be expressed as: a total area of 1.2 m² per PE, divided over 3 identical alternately fed units on the first stage (i.e. an organic load of ≈ 300 g COD m⁻².d⁻¹, - 150 g SS m⁻².d⁻¹, and $\approx 25-30$ g TKN m⁻².d⁻¹ and a (HL) of 0.37 m.d⁻¹ on the filter in operation), and 0.8 m² per PE divided over 2 identical alternately fed units for the second stage. This design is based on a ratio of 120 g COD.PE⁻¹, 60 g SS.PE⁻¹, 10-12 g of TKN.PE⁻¹ and 150 L.PE⁻¹ as most often observed for small communities in France.

Wastewater is supplied to the filters in hydraulic batches (by a storage and high capacity feeding system) to ensure an optimum distribution of wastewater and SS over the whole available infiltration area and improve oxygen renewal. When the difference in height between the inlet and outlet of the plant is sufficient, the plant operates without an energy source thanks to self-priming siphons. This configuration is known to allow significant removal of COD, TSS and almost complete nitrification (Boutin *et al.*, 1997). In view of the

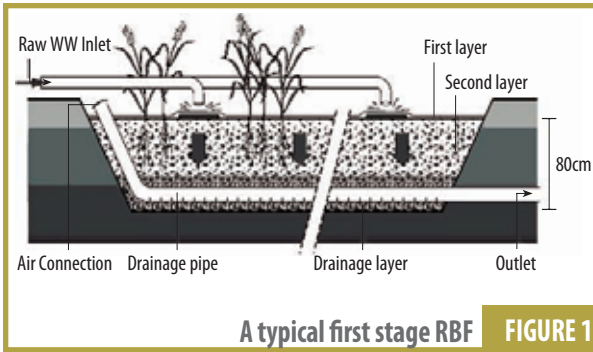

A typical first stage RBF **FIGURE 1**

First Stage	Second Stage
> 30 cm fine gravel (2-8mm)	> 30 cm of sand (0.25mm<d10 <0.40mm)
Transition layer: 10 to 20cm of adapted particle size (5-20mm)	Transition layer: 10 to 20cm of adapted particle size (3-10mm)
Drainage layer: 10 to 20cm of 20-40mm	Drainage layer: 10 to 20cm of 20-40mm

Partical size profiles **FIGURE 2**

popular success of VFCWs for small communities, and knowing that design recommendations have not yet been fixed, the recently created French Macrophytes Group initiated an investigation to give an overview of the number of plants, their design, their efficiency and the problems which could occur. The aim was to correct design deviations that might have occurred. This paper relates the overview given by the survey and the design lessons that can be drawn from it.

Materials and methods

Data collection in relation to the national situation was carried out by sending questionnaires to the local technical services for wastewater treatment plants (SATESE), in order to ascertain the different conception characteristics and behaviour of VFCW plants in operation in France. Using data, a sample of 72 plants was chosen to assess pollutant removal efficiency and increase the database on wetland efficiency. The sample chosen is representative of the national situation. 60% of the plants are 4 to 6 years old, 60% treat only domestic wastewater and the average plant capacity is 410 PE (median 325 PE). We took care to evaluate the situation at different altitudes (between 0 and 1000 m).

The efficiency study was done by a 24-hour flow composite sampling at different time of the year (summer and winter). As far as possible each stage of treatment plant was evaluated for COD, BOD, SS, TKN, N-NH₄, TP and P-PO₄ according to French standard methods. Flow was measured by venturi ditches or by measuring the functioning time of pumps if present. Knowing that the percentage of N in the SS of raw sewage is about 3 to 5% and about 0.7% in the sludge deposit (Molle, 2003), the TKN removal observed is assumed to be due to nitrification only. Such an approximate calculation is considered more reliable than those based on nitrate concentration because of the difficulty of assessing nitrogen balance due to nitrate leachate during the rest period. All removal efficiencies are calculated as kg of pollutant removed. Statistical analysis of the data is necessary for comparison of efficiency in relation to design characteristics as a number of sources of uncertainty can affect the quantitative measurement (different operators and methods in some cases). Analyses of variances and mean comparison were performed at p = 0.05 by the Fisher F-test

and the Student t-test, taking the samples two at a time. The confidence interval (95% of the values) is determined by $\pm 2 \frac{SD}{\sqrt{N}}$, where N is the number of values and SD the standard deviation.

Results and discussion

VFCW situation

Over 200 plants are actually in operation and more than 60 plants were built in the year 2003 (figure 3). The results are not complete because only 61 out of 95 departments answered the questionnaire. Nevertheless, it indicates that VFCWs have become popular for small communities. The survey revealed 213 plants in France treating wastewater with VFCW (65% < 300 PE) with a design close to the one recommended by Cemagref with some deviations (min - max on the 1st stage: 0.1 - 4.7m². PE⁻¹; 2nd stage: 0.1 - 3.6m². PE⁻¹). Differences in surface sizing result from adaptation to influent characteristics (presence of clear water for example). About 70% of these plants treat wastewater from separate network systems, 10% wastewater from separate networks with clear water intrusion and 20% wastewater from combined network systems. Feeding systems mainly use gravity (60% by siphon on the first stage and 75% on the second stage) and thus avoid the necessity of an electrical source to the plant.

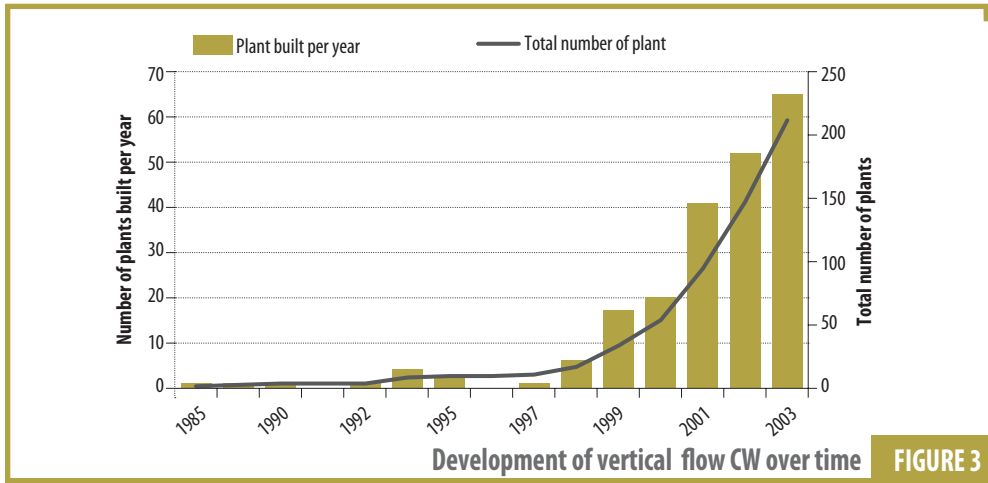

FIGURE 3

Removal efficiency was studied by 233 assessments on 81 plants (Table 1). We focused our analysis on the vertical + vertical design fed with raw wastewater. This meant that all the first stage vertical filters fed with raw sewage were taken into account in order to focus our analysis on the performance of this first stage whatever the following stages. The performances of second stage vertical flow systems are examined separately.

TABLE 1 Types of evaluated plants

TYPE OF PLANT	NUMBER OF PLANT	ASSESSMENT NUMBER	PLANT AGE (Y) AT THE ASSESSMENT
V+V	53	134	0 - 7.0
V+H	2	33	1.2-8.0
V+SF	7	11	0.4-2.0
V	5	5	0.6-4.6
V+P	3	12	0.2-2.5
V+V+H	1	9	Start up
V+H+P	1	6	11.6-15.0
V+H+H	2	3	0.6-2.3
V+H+P	2	3	1.2
V+P+V	1	2	1.6-8.5
V+H+V	1	1	2.6
P+V	1	9	0-1.0
P+V+V	1	3	?
H+V+H	1	2	3.5-4.0

Global efficiency

For the typical design of two stages of vertical flow filter fed with unsettled wastewater, large variations were observed on the filter in operation at the first stage in hydraulic load ($\text{Mean}_{\text{HL}} = 0.37 \text{ m.d}^{-1}$; $\text{SD} = 0.38$; $\text{min-max} = 0.03\text{-}3.9 \text{ m.d}^{-1}$) and organic load ($\text{Mean}_{\text{COD}} = 223 \text{ g.m}^{-2}.\text{d}^{-1}$; $\text{SD} = 260$; $\text{min-max} = 17\text{-}1680 \text{ g.m}^{-2}.\text{d}^{-1}$). Consequently, and also because of differences in design, age of the plant etc., removal efficiency varied. If cases of abnormally high hydraulic load resulting in very diluted influent are excluded, the potential of the filters for good pollutant removal can be observed. Table 2 shows the removal efficiency and outlet concentration for plants with hydraulic loads lower than 0.75 m.d^{-1} on the filter in operation on the first stage (2 times the dry weather HL). Globally systems are able to achieve good effluent quality for all but phosphorus removal and denitrification (denitrification is not present due to the enhanced aerobic conditions, and mean P removal is about 40%).

TABLE 2 Removal and outlet pollutant concentration of two stage VFCW's for Hydraulic Loads $<0.75 \text{ m.d}^{-1}$

PLANT AGE (y)		COD		SS		TKN	
		% Removal	Outlet Concentration mg.L^{-1}	% Removal	Outlet Concentration mg.L^{-1}	% Removal	Outlet Concentration mg.L^{-1}
2-6	Mean (N)	91 ± 3 (48)	66 ± 13 (49)	95 ± 2 (49)	14 ± 5 (49)	85 ± 5 (49)	13 ± 5 (49)
	SD	10.2	45.5	5	17.5	17.1	17.5
<2	Mean (N)	90 ± 2 (43)	65 ± 15 (51)	94 ± 4 (43)	15 ± 6 (51)	85 ± 6 (43)	12 ± 5 (49)
	SD	7.1	51	12.2	19.7	18.4	15.7

Very often improvement in treatment is mentioned by operators with sludge deposit evolution on the first stage over the first years of operation. This effect is not observed over the two stages of treatment where no significant differences are observed between newer and older plants. The second stage of filters ensures treatment efficiency. Some limitations can be observed for nitrification due to its sensitivity to oxygen presence and competition with COD removal. Several parameters such as flow distribution, batch frequency, type and depth of media etc. can influence oxygen renewal. This probably explains the nitrification variation performance observed. These variations in our samples can be correlated to the surfaces used but not to hydraulic or COD load. For comparable HL ($0.20 \text{ m}\cdot\text{d}^{-1}$) and inlet concentrations ($\text{TKN}_{\text{inlet}} = 80 \pm 15 \text{ mg}\cdot\text{L}^{-1}$), TKN outlet concentrations differ significantly according to surface per PE. Outlet concentrations clearly show the limitation in using global surfaces of below $2 \text{ m}^2\cdot\text{PE}^{-1}$ (See table 3). It does not seem necessary to design plants with an area greater than $2.5 \text{ m}^2\cdot\text{p}\cdot\text{e}^{-1}$ for better nitrification but $2 \text{ m}^2\cdot\text{PE}^{-1}$ is a prerequisite in order to achieve $8 \text{ mg TKN}\cdot\text{L}^{-1}$ ($6 \text{ mg N-NH}_4\cdot\text{L}^{-1}$).

TABLE 3 Outlet TKN concentration of two stage VFCWs according to the size

Total surface area	$1.5 - 2 \text{ m}^2\cdot\text{p}\cdot\text{e}^{-1}$	$2 - 2.5 \text{ m}^2\cdot\text{p}\cdot\text{e}^{-1}$	$2.5 - 3 \text{ m}^2\cdot\text{p}\cdot\text{e}^{-1}$
TKN outlet ($\text{mg}\cdot\text{L}^{-1}$) (N)	16 ± 8 (28)	6 ± 2 (20)	5.6 ± 3 (10)

First stage of treatment

46 assessments were used to evaluate the performance of first stage treatment. As plant design, hydraulic and organic load vary, it is not easy to estimate the precise impact of design on removal performances. Nevertheless it can be observed that the first stage of treatment concerns mainly SS and COD removal, though TKN removal is not negligible (see table 4).

High SS removal performance is obtained on the first stage due mainly to the deposit on the filter surface. This deposit layer is of great importance in limiting the infiltration rate and thereby the hydraulic flow that can pass through the filter. The effect of this restricting factor, which influences the hydraulic load which can be accepted whilst allowing enough surface aeration time, is reduced by reed growth over the year (Molle, 2003). Nevertheless no significant differences in pollutant removal were observed over the year even with hydraulic loads of up to two times the dry weather flow.

Figures 4 and 5 present the removal performances in relation to the organic load (100% removal represented by the dotted line). Even for organic loads greater than those allowed for in the design, COD and SS removal are acceptable. For low hydraulic loads, a greater variation in COD removal is observed ($80 \pm 6\%$; $N = 15$). This can be related to the fact that during poor loading water distribution, and therefore the sludge deposit, is not homogeneous. Heterogeneity in distribution can lead to some deficiencies in COD removal due to flow short-circuiting. COD removal is sensitive to infiltration rate (Molle, 2003). SS removal appears relatively stable and efficient. This is not the case for nitrification (see figure 5). Nitrification for nominal TKN loads ($25\text{-}30 \text{ g}\cdot\text{m}^{-2}\cdot\text{d}^{-1}$) can be expected to be about 50%.

Variations in nitrification efficiency can not be correlated with plant design, plant age or media depth, for global oxygen demand ($GOD = DCO + 4.57 \cdot TKN$) of between 40 and 110% of the nominal load, and hydraulic loads of between 40 and 160% of the nominal load. In fact we observed a tendency to improve TKN removal over the year. The winter period, with lower mineralisation of sludge deposit and low temperature, is the worst for biological activity. Nitrification is probably the first to be affected by these limiting conditions. Moreover, the period from January to April is affected by a longer period of accumulation of sludge (from November) which remains wet leading to poor mineralisation. This contributes to a limitation in infiltration rate and oxygen renewal.

TABLE 4 Removal and outlet pollutant concentration of the first of VFCW for hydraulic loads $<0.6 \text{ m.d}^{-1}$

		COD		SS		TKN	
		% Removal	Outlet concentration mg.L^{-1}	% Removal	Outlet concentration mg.L^{-1}	% Removal	Outlet concentration mg.L^{-1}
2-6	Mean (N)	79 ± 3 (54)	131 ± 20 (54)	86 ± 3 (54)	33 ± 6 (54)	58 ± 5 (54)	13 ± 5 (54)
	SD	10	71	12	19	17	17
<2	Mean (N)	82 ± 3 (34)	145 ± 24 (34)	89 ± 3 (34)	33 ± 7 (34)	60 ± 6 (34)	35 ± 7 (34)
	SD	7	70	7	19	16	18

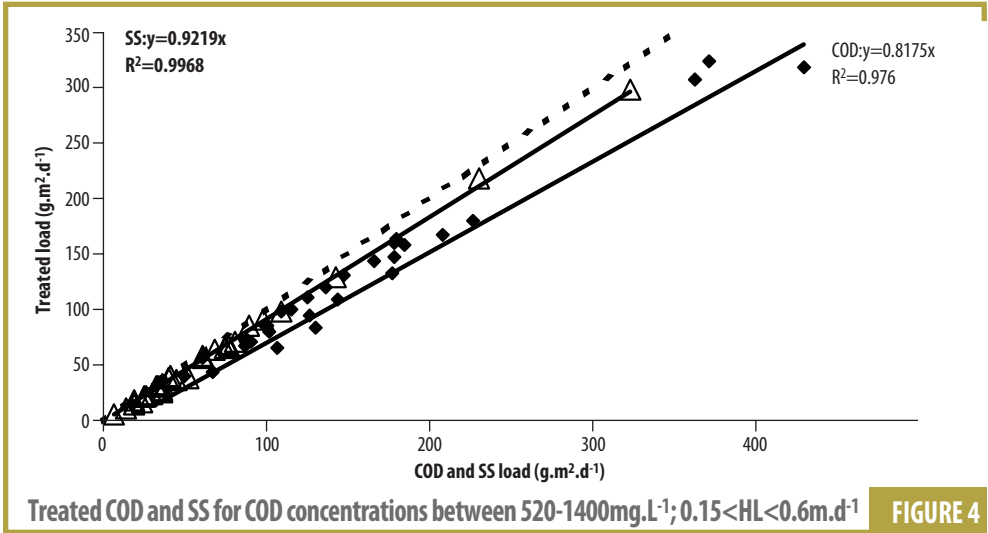

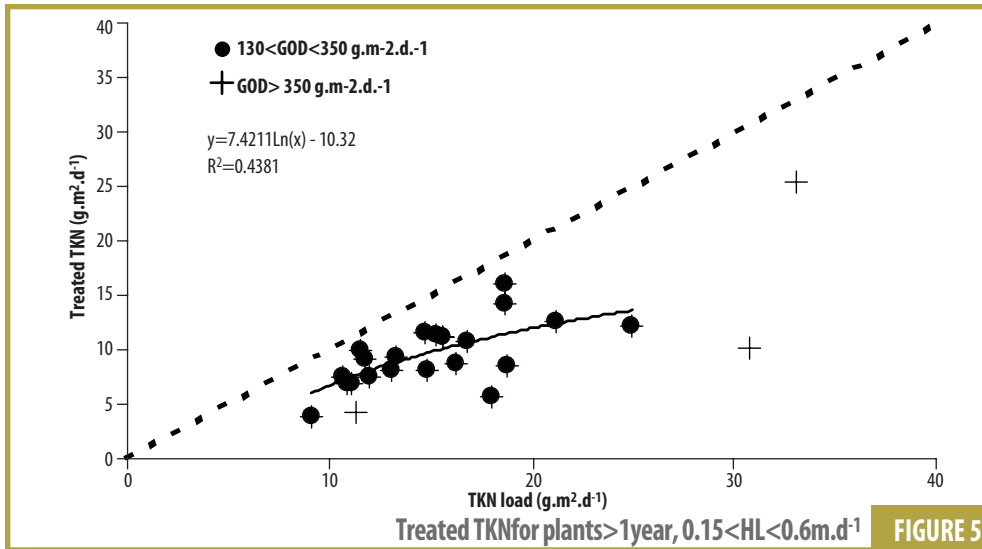

Second stage of treatment

As shown in table 5, the second stage of treatment has a mainly nitrification contribution. Because of low inlet concentrations in COD and SS (about 140 and 40 mg.L⁻¹ respectively), this second stage has only a polishing effect on these parameters.

No correlation was observed between removal rate and size of the filter. For COD removal high hydraulic loads seem to decrease efficiency (figure 6). This was shown by Molle (2003) in laboratory column experiments. COD removal is sensitive to the hydraulic retention time. There was no correlation between outlet COD concentration and hydraulic load. Hydraulic overload decreases COD removal but is compensated for by the dilution effect. Therefore outlet concentration remained low. More information would be necessary in order to analyse in what way design characteristics contribute to changes in removal efficiency. In our study media depth and characteristics were not always noted or not precise enough to allow observations of media influence on removal levels. The overall flow distribution on the filter surface is of great importance. This information (flow of feeding systems) would have been invaluable in order to define quality of distribution over the surface. Nevertheless we can observe that globally nitrification has the same rate of efficiency as that the observed by Molle (2003) in a study performed under better controlled conditions (Figure 8). Some assessments (9 out of 53) carried out by SATESE deviate from this correlation for low TKN loads (Figure 8). No clear nor general reason could be established because of the numerous different conditions that could have affected nitrification rates (low inlet concentration due to diluted effluent, presence of industry, use of natural soil as a medium etc).

Most importantly, it would seem that good feeding flow conditions are essential. More precise studies need to be done to evaluate in what way distribution and batch frequency can modify nitrification rate.

TABLE 5 Removal and outlet pollutant concentration of the second stage of VFCW for Hydraulic loads $<0.6 \text{ m}\cdot\text{d}^{-1}$

		COD		SS		TKN	
		% Removal	Outlet Concentration $\text{mg}\cdot\text{L}^{-1}$	% Removal	Outlet Concentration $\text{mg}\cdot\text{L}^{-1}$	% Removal	Outlet Concentration $\text{mg}\cdot\text{L}^{-1}$
All assessments	Mean (N)	56 ± 12 (44)	51 ± 7 (44)	65 ± 10 (44)	11 ± 3 (44)	71 ± 7 (44)	7 ± 2 (44)
	SD	38	23	34	9	23	6
80 < COD < 280 (mean 140) $\text{mg}\cdot\text{L}^{-1}$	Mean (N)	60 ± 8 (28)	55 ± 8 (29)	72 ± 7 (28)	11 ± 4 (29)	78 ± 7 (28)	6 ± 2 (29)
	SD	21	21	19	9	18	5

Nevertheless we found that nitrification met the treatment objectives for loads below $15 \text{ g}\cdot\text{m}^{-2}\cdot\text{d}^{-1}$ of TKN on the second stage filter in operation. For loads above this level, a decrease in nitrification rate was observed. This is of no importance in respect to outlet levels if the high load is due to a high hydraulic load of diluted influent because outlet concentration will meet quality objectives. However if it is due to the small surface area of the unit it could be difficult to achieve 90% of nitrification over the whole plant.

Sludge accumulation and handling

Up to now, sludge removal has only been carried out on one plant designed for 1600 p.e. and composed of 8 VFCWs prior to 3 WSPs (dimensioned at $5 \text{ m}^2/\text{p.e.}$). The plant was put in operation in 1987. Sludge removal was required in 1996, not because of deterioration in effluent quality, but because there was an unequal height of sludge causing distribution problems and little remaining availability of freeboard with risk of spillover in winter. The poor distribution was due to an insufficient flow rate of the pumping station a long way away from the plant and an unsuitable distribution gully. The average sludge height was estimated to be 13 cm (minimum 6 cm, maximum 27 cm). In 1999, after this sludge removal from 6 filters, the pump and distribution system were changed to give a better distribution of SS over the surface area.

In March 2001 the accumulated sludge on the 2 filters which had not been removed since the beginning of operation (June 1987) had reached approximately 25 cm over the entire surface of each filter and the freeboard was not sufficient to guarantee treatment of daily hydraulic peaks. From these measurements, it can be confirmed that in this plant sludge height increases at about 15 mm per year. Several samples of the different layers of sludge were analysed in order to determine their degree of mineralisation (Table 6). Because of hydraulic experiments and wet weather, just before sludge removal, drying conditions were not optimal. Nevertheless, the dry matter content was always greater than 20%, except at the top where the deposits were most recent. Mineralisation which occurs over time induces DM and OM gradients over the sludge height. Analyses confirm a relatively high DM content in relation to the wet conditions prevailing at the time. Probably the mineralisation provided a structure to the sludge which allowed rapid percolation of water and prevented it from staying too wet.

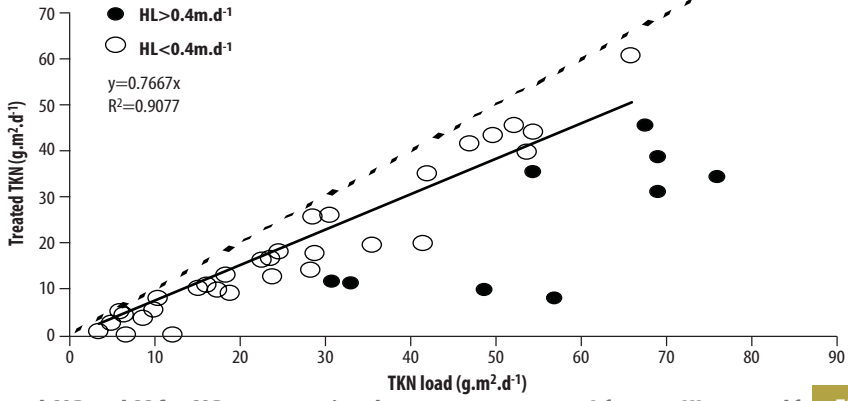

Treated COD and SS for COD concentrations between 520-1400mg.L⁻¹; 0.15 < HL < 0.6m.d⁻¹ **FIGURE 6**

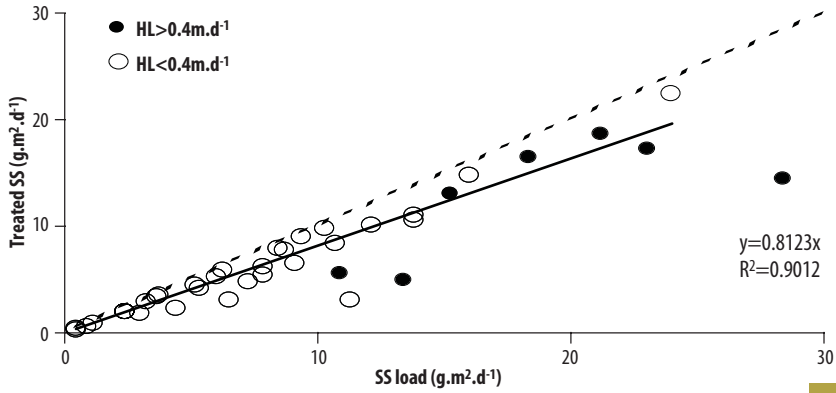

Treated SS on 2nd stage **FIGURE 7**

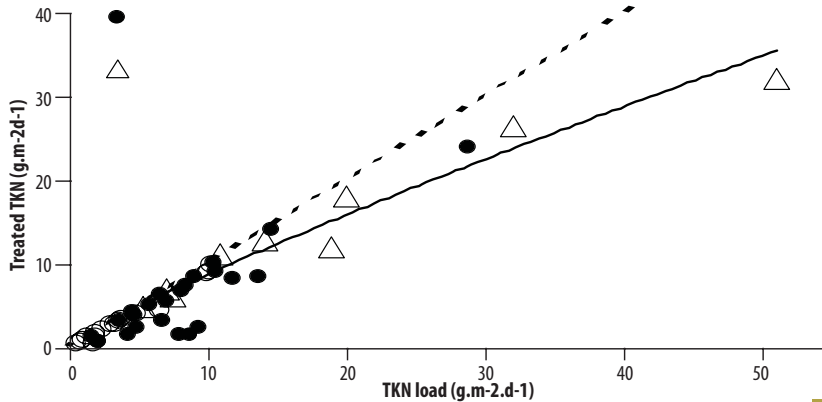

Treated TKN on 2nd stage (0.05 < hl < 2.2 m.d⁻¹) **FIGURE 8**

TABLE 1 Quality of the sludge on the two filters at Gensac la Pallue in 2001

		DRY MATTER (G.KG ⁻¹)		ORGANIC MATTER (% OF DM)	
Filter 7	Top Layer		181.0		61.2
	Middle Layer	214.5	205.0 Mean = 261,8 365.9*	51.5	54.9 Mean = 42,96 22.5
	Lower Layer		291.6		39.8
	Removed sludge**		284.0		34.3
Filter 6	Top Layer		154.0		54
	Middle Layer		213.2		48.3
	Lower Layer	218.1	Mean = 264,3 310.5	45.3	Mean = 41,5 37.8
	Removed sludge**		217.8		49.2
Sludge stored since the first withdrawal in 1996			583.0		10.4

* this large amount can be explained by the location of this sample, at the end of the filter, very little fed before 1999, because of distribution device failure as mentioned previously.

** made up of several mixed sludge samples taken out during the withdrawal from one filter.

Based on a daily SS load of 16.3 kg and a SS removal rate of 90%, the mass balance of SS input on these 2 filters over 14 years can be calculated to be 75000 kg SS. The evacuated mass (mean height 22.5 cm, DM content 25% and surface area of the 2 filters 520 m²) is estimated to be 29000 kg SS, which represents almost 39% of the SS introduced with the wastewater. Thus, the mineralisation rate attained was 61% and is similar to a previous estimation of 65% Boutin *et al.* (1997). This aerobic mineralisation, as evidenced by the presence of many *Lumbricus* earthworms, can also be explained by the fact that, once roughly dewatered (i.e. 15% SS content), the SS retained on the deposit surface represents a height not exceeding 1.5 mm per week before any mineralisation process has occurred. Such a thin layer is in direct contact with the atmosphere most of the time. Bacteria in the sludge layer, which are in optimum hygrometry and protected from UV by the shade of the reeds, can easily start their aerobic activity.

This deposit layer becomes part of the biologically efficient media and tends to increase the removal rates of COD, TSS and TKN. Increase in deposit layer does not drastically affect the hydraulic capacity of the filter. In fact, due to the mechanical role of reeds (Molle 2003), it is only the thin layer of newer deposits which is hydraulically limiting. The sludge withdrawal did not affect the regrowth of the reeds from the rhizomes. Metal analysis of sludge (Molle 2003) showed that its use for agricultural purposes is possible as long as no agro-industries have been connected to the sewerage network (for example copper from vineyards treatment).

Conclusion

This study gives an overview of the performance of the many various design and functioning characteristics of VFCW in France. Globally, this system is very appropriate for small communities because treatment is extremely efficient (>90% for COD, 95% for SS and 85% for nitrification) despite variations in organic and hydraulic loads (15% of the assessments showed organic loads higher than the nominal COD load and 25% hydraulic loads higher than the nominal load). The first stage of treatment operates an COD and SS removal while nitrification is variable and about 50% of inlet TKN. The second stage of treatment secures carbon removal (COD and SS) and completes the nitrification. The effect of design on pollutant removal rate (size, material characteristics etc.) can not be proved statistically. Nevertheless, as it is more sensitive to oxygenation and functioning conditions, nitrification is a suitable parameter for observation of the appropriateness of the plant design and/or functioning in pollutant removal performance. In this study, design data were either not obtained or not precise enough in terms of material depth, material size distribution, siphon volume, pump flow etc. to determine how nitrification could be improved by design or optimal management. Nevertheless we can state that $2 \text{ m}^2 \cdot \text{PE}^{-1}$ is a prerequisite in order to attain sufficient nitrification. Sizes greater than $2.5 \text{ m}^2 \cdot \text{PE}^{-1}$ do not appear to improve nitrification. Performance of each stage in relation to organic, and in some cases hydraulic, loads allow the potential of the system to be more clearly defined. For nominal loads we can state that $1.2 \text{ m}^2 \cdot \text{PE}^{-1}$ on the first stage and $0.8 \text{ m}^2 \cdot \text{PE}^{-1}$ on the second stage allow outlet concentrations of $60 \text{ mg} \cdot \text{L}^{-1}$ in COD, $15 \text{ mg} \cdot \text{L}^{-1}$ in SS and $8 \text{ mg} \cdot \text{L}^{-1}$ in TKN to be reached. Hydraulic overloads can affect COD removal (observed on the second stage of treatment) but outlet concentration is maintained due to the dilution effect. In relation to removal rate observed for each stage, nitrification could be improved by increasing the first stage sizing to $1.5 \text{ m}^2 \cdot \text{PE}^{-1}$ to obtain an outlet concentration of about $6 \text{ mg} \cdot \text{L}^{-1}$. However this would lead to more wastewater distribution problems. In fact, flow feeding of the first stage is of great importance to assure an overall distribution of water onto the filter to use the whole reactor. More studies need to be done to accurately determine the optimal conditions for feeding (flow, volume, frequency) in order to improve nitrification, but in our experience, it seems that a feeding flow of $0.6 \text{ m}^3 \cdot \text{m}^{-2} \cdot \text{h}^{-1}$ is the minimum. This flow would ensure a satisfactory distribution for the first feeding after a rest period, when infiltration rates can be greater than $1.4 \cdot 10^{-4} \text{ m} \cdot \text{s}^{-1}$ (Molle, 2003). Such a feeding flow would ensure a good sludge and water distribution on the filter. The deposit layer on the first stage limits the infiltration rate and improves water distribution. It also supplements the biologically active layer. Mineralisation (60%) leads to an increase in sludge of about 1.5 cm per year which must to be removed once it attains a maximum of 20 cm i.e. about every 10-15 years. Sludge can be used for agricultural purposes as long as no industries are connected to the sewerage network.

Acknowledgements

The authors would like to thank the “Rhône Méditerranée Corse” water authorities for their financial support, SATESE for their contribution to data provided and H. Zowal and H. Burnett for help provided.

References

Boutin, C., Lienard, A. and Esser, D. (1997). Development of a new generation of reed-bed filters in France : First results. *Wat. Sci. Tech.*, **35** (5), pp 315-322.

Liénard, A. (1987). Domestic wastewater treatment in tanks with Emergent Hydrophytes : latest results of a recent plant in France, *Wat. Sci. Tech.*, **19**, (12), pp 373-375.

Liénard, A., Boutin, C. and Esser, D. (1990a). Domestic wastewater treatment with emergent hydrophyte beds in France. *In : Constructed Wetlands in Water Pollution Control (Adv. Wat. Pollut. Control n°11)*. Ed. Cooper P.F. and Findlater B.C. Pergamon Press, UNITED KINGDOM, pp 183-192.

Liénard, A., Esser, D., Deguin, A. and Virloget, F. (1990b). Sludge dewatering and drying in reed beds : an interesting solution ? General investigation and first trials in France. *In : Constructed Wetlands in Water Pollution Control (Adv. Wat. Pollut. Control n°11)*. Ed. Cooper P.F. and Findlater B.C. Pergamon Press, UNITED KINGDOM, pp 257-267.

Liénard, A., Boutin, C. and Esser, D. (1998). France. *In : “Constructed wetlands for wastewater treatment in Europe.”*, Ed. Vymazal J., Brix H., Cooper P.F., Green M.B., Haberi R., 1998, Backhuys Publishers, Leiden, NETHERLANDS, pp.153-168.

Molle P., (2003). Subsurface flow constructed wetlands: Phosphorus retention and hydraulic limit of vertical subsurface flow CWs. (In French) PhD Thesis, engineering processes speciality. University of Montpellier, 267 p.



UN-HABITAT

Andre Dzikus

Chief, Water and Sanitation Section II
Water, Sanitation and Infrastructure Branch
UN-HABITAT

P.O.Box 30030, Nairobi, Kenya
Tel +254-20-7623060, 7625082
Fax +254-20-7623588
Email andre.dzikus@unhabitat.org
Web www.unhabitat.org | www.unwac.org

Kulwant Singh

Chief Technical Advisor
Water for Asian Cities Programme, Regional Office
EP 16/17, Chandragupta Marg, Chanakyapuri
New Delhi - 110 021, India

Tel +91-11-4222 5000
Fax +91-11-2410-4961
Email Kulwant.Singh@unhabitat.org

Roshan Raj Shrestha

Chief Technical Advisor
UN-HABITAT Water for Asian Cities Programme Nepal
UN House, Pulchowk, Lalitpur

P.O. Box 107, Kathmandu, Nepal
Tel +977-1-5542816
Fax +977-1-5539877
Email roshan.shrestha@unhabitat.org.np
wac.nepal@unhabitat.org.np

